

Safety Precautions

Description of safety labels:



Danger: If not avoided, could result in death, serious injury and considerable damage to property.



Note: If not avoided, may cause minor or moderate injury and equipment damage.

■ Use



Danger

- This series of inverter is used to control the three-phase motor and cannot be used for single-phase motor or other applications. Otherwise, inverter fault or fire may happen.
- This series of inverter cannot be simply used in the applications directly related to the human safety, such as the medical equipment.
- This series of inverter is produced under strict quality management system. But if the inverter fault may cause severe accident or loss, safety measures such as redundancy and bypass, shall be taken.

■ Goods Arrival Inspection



Note

- If the inverter is found damaged or missing parts, the inverter cannot be installed. Otherwise, accident may be caused.

■ Installation



Note

- When moving and installing the product, please hold the product bottom. Do not hold the enclosure only. Otherwise, your feet may be injured and the inverter may be damaged because of dropping.
- The inverter shall be mounted on the fire retardant surface, such as metal, and kept far away from the flammables and heat producer.
- The drilling scraps keep away from the inverter during installation; otherwise, inverter may be damaged.
- When the inverter is installed inside the cabinet, the electricity control cabinet shall be equipped with fan and ventilation port. And air cooling duct shall be constructed in the cabinet.

■ Wiring



- The wiring must be conducted by qualified electricians. Otherwise, electric shock may happen or inverter may be damaged.
- Before wiring, confirm that the power supply is disconnected. Otherwise, electric shock may happen or fire.
- The PE terminal must be grounded firmly; otherwise, the inverter enclosure may become live.
- Please do not touch the main circuit terminals. The wires of the main circuit terminals must not contact the inverter enclosure. Otherwise, electric shock may happen.
- The connecting terminals for the braking resistor are ⊕2/B1 and B2. Please do not connect terminals other than these two. Otherwise, fire may be caused.
- The leakage current of the inverter system is more than 3.5mA, and the actual value of the leakage current is determined by the operation application conditions. Inverter and the motor must be grounded firmly to ensure the safety.

■ Wiring



- The three-phase power supply cannot connect to output terminals U/T1, V/T2 and W/T3; otherwise, the inverter will be damaged.
- It is forbidden to connect the inverter output terminals to the capacitor or LC/RC noise filter with phase lead, otherwise, the internal components of the inverter may be damaged.
- Please confirm that the power supply phases and rated input voltage are consistent with those indicated by the nameplate, otherwise, the inverter may be damaged.
- Do not perform dielectric strength test on the inverter, otherwise, the inverter may be damaged.
- The wires of the main circuit terminals and the wires of the control circuit terminals shall be laid separately or in a square-crossing mode, otherwise, the control signal may be interfered.
- The wires of the main circuit terminals should adopt lugs with insulating sleeves.
- The sectional area of input and output cables should be selected according to the inverter power.
- When the cables between the inverter and the motor are longer than 100m, it is suggested to use output reactor to avoid the over current fault caused by the distribution capacitor.
- If the inverter equipped with a DC reactor, DC reactor must be connected between the terminals of ⊕1 and ⊕2, otherwise the inverter will not display after power on.

■ Operation



- Power supply can only be connected after the wiring is completed and the cover is installed. It is forbidden to remove the cover in live condition; otherwise, electric shock may happen.
- When automatic fault reset function or restart function is enabled, isolation measures shall be taken for the mechanical equipment, otherwise, personal injury may be caused.
- When the inverter is power on, its terminals are still live even when in stop state. Do not touch the inverter terminals; otherwise electric shock may happen.
- The fault and alarm signal can only be reset after the run command has been cut off. Otherwise, personal injury may be caused.



- Do not start or shut down the inverter by switch on or off the power supply, otherwise, the inverter may be damaged.
- Before operation, please confirm whether the motor and equipment are in the allowable use range, otherwise, the equipment may be damaged.
- The heat-sink and the braking resistor have high temperature. Please do not touch such device; otherwise, you may be burnt.
- When it is used in the application of crane or lifting equipment, mechanical brake should also be equipped.
- Please do not change the inverter parameters randomly. Most of the factory settings can meet the requirement, and the user only needs to set some necessary parameters. Any random change of the parameter may cause the damage of the mechanical equipment.
- In the applications of changeover between power frequency and variable frequency, the two contactors for controlling the changeover between power frequency and variable frequency must be interlocked.

■ Maintenance, Inspection



- In the power-on state, please do not touch the inverter terminals; otherwise, electric shock may happen.
- If the cover is to be removed, the power supply must be disconnected first.
- Waiting for at least 10 minutes after power off or confirm that the CHARGE LED is off before maintenance and inspection to prevent the human injury caused by the residual voltage of the electrolytic capacitor in main circuit.
- The components shall be maintained, inspected or replaced by qualified electricians.



- The circuit boards have large scale CMOS IC. Please do not touch the board to avoid the circuit board damage caused by ESD.

■ Others



- It is forbidden to modify the inverter unauthorizedly; otherwise, human injury may be caused.

Control Mode Setting Process

1. Setting Process for Motor Data Identification

Motor data identification at standstill

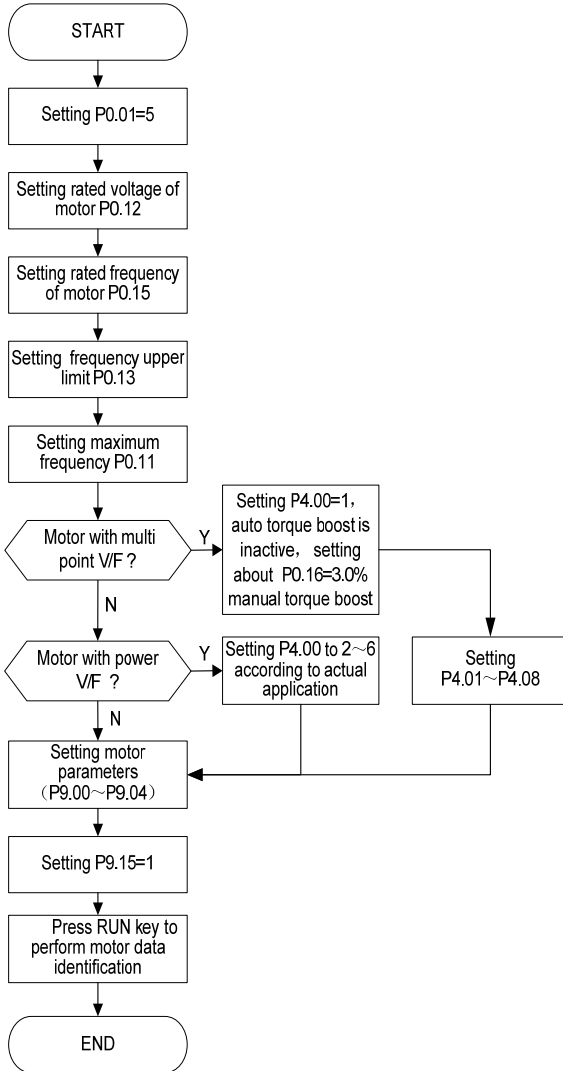

Complete motor data identification

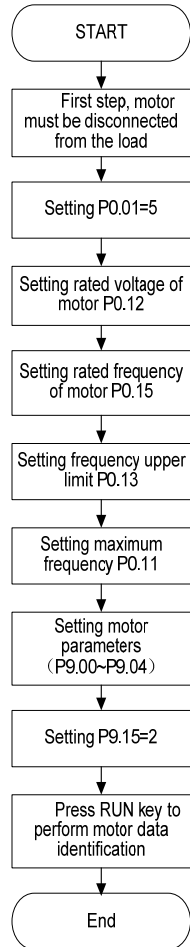

2. Setting Process for Open Loop

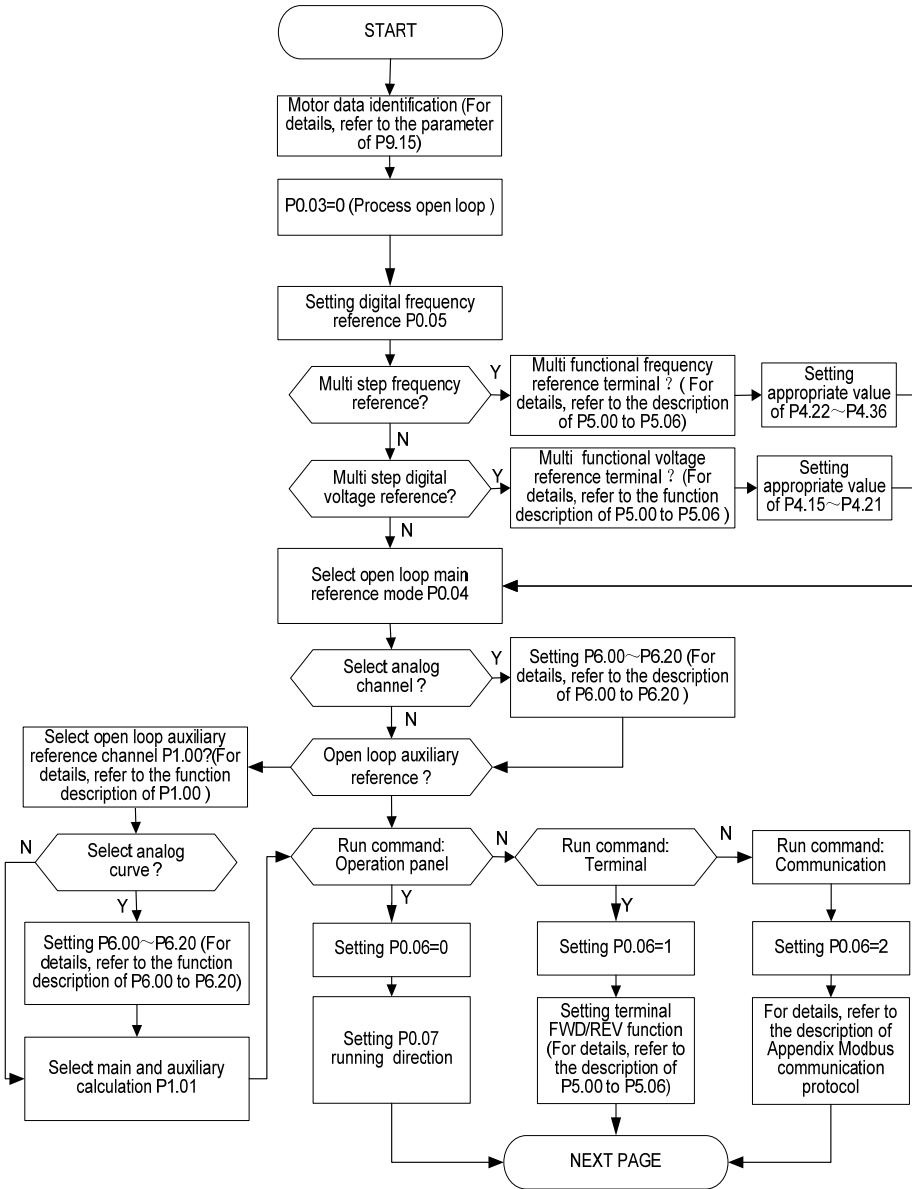

Open loop setting process (continued)

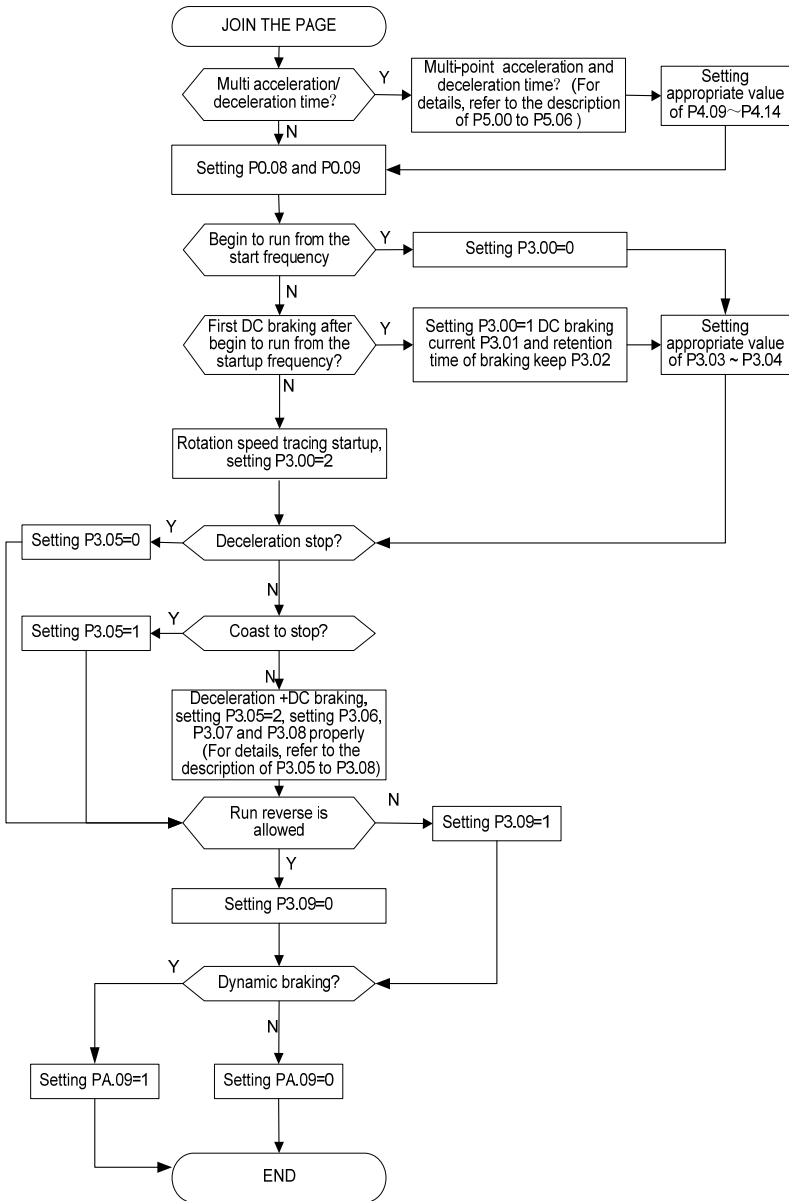

3. Setting Process for Closed Loop

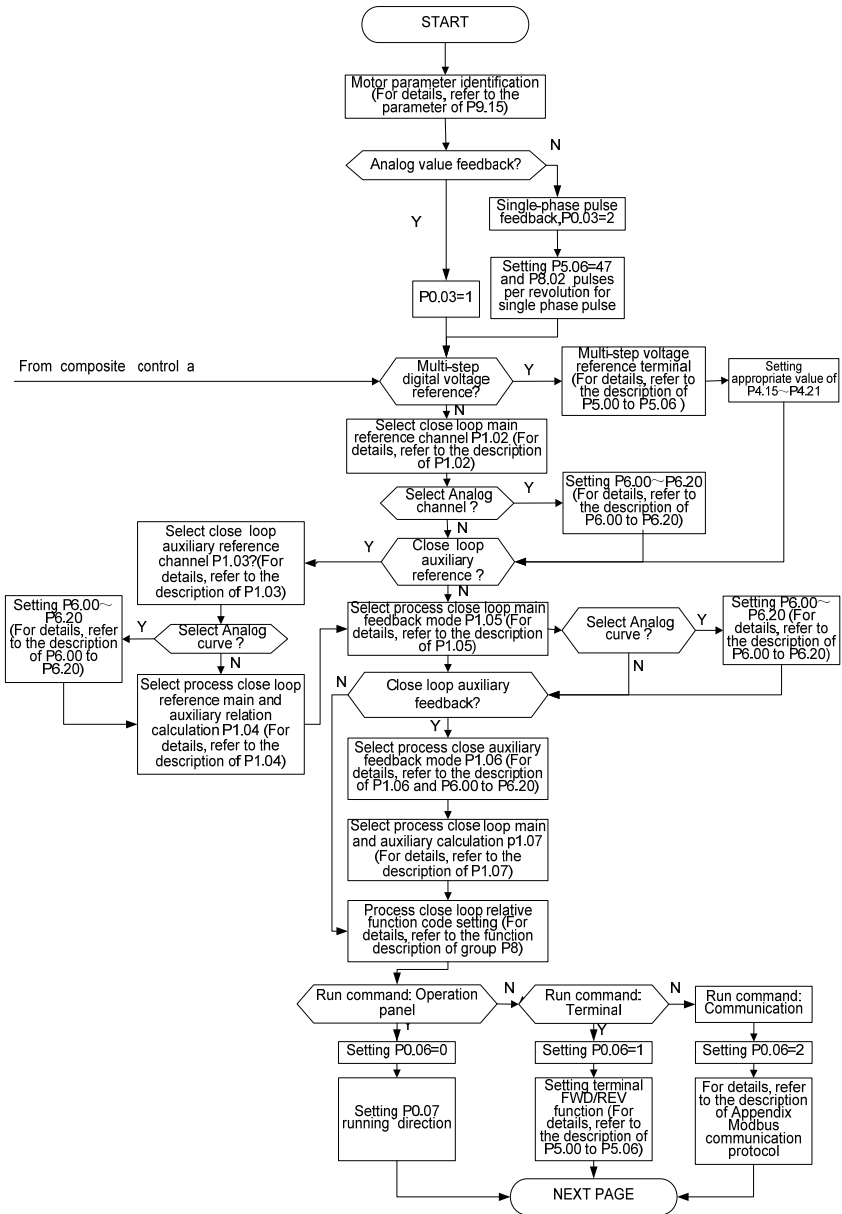

Setting Process for Closed Loop (continued)

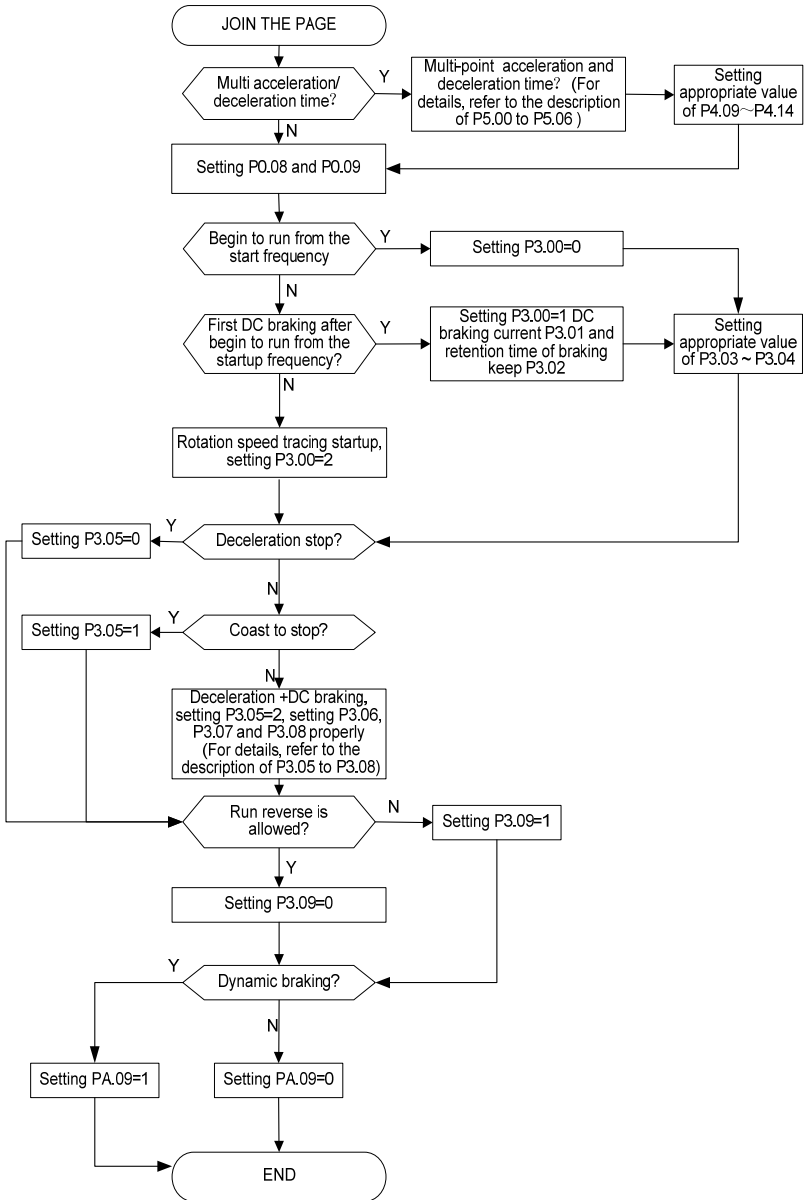

4. Setting Process for Composite Control

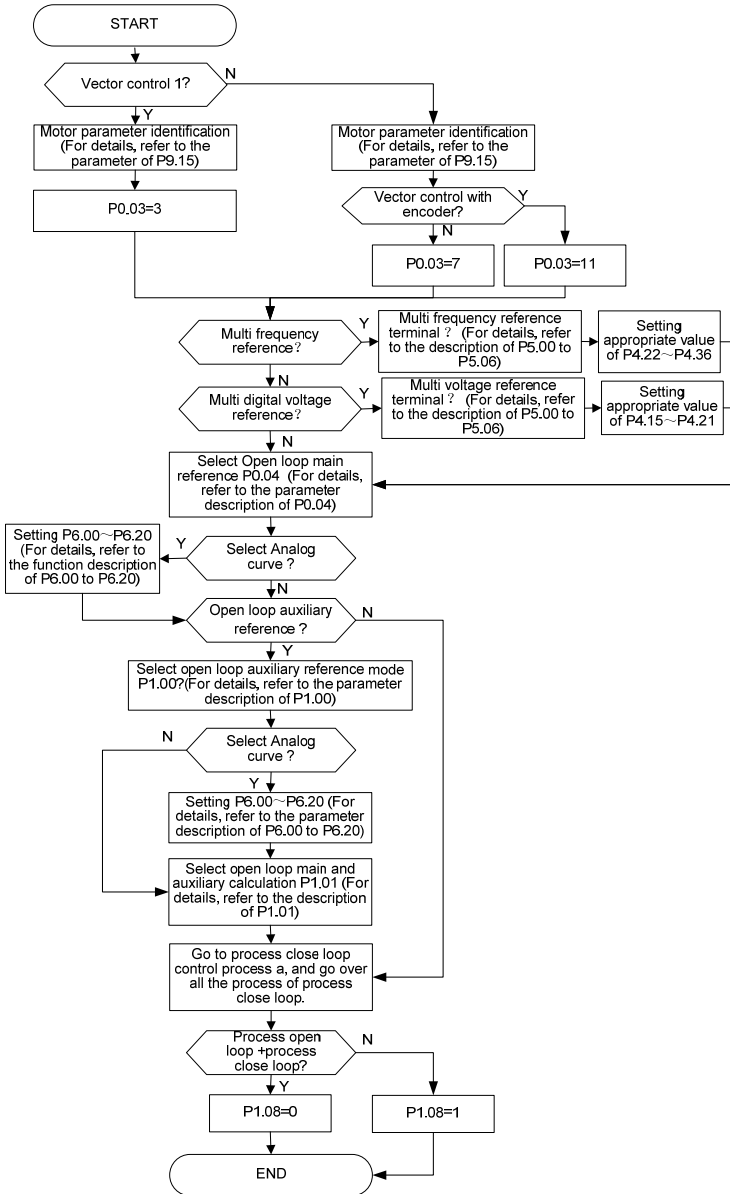

Contents

Safety Precautions	i
Control Mode Setting Process	iv
Chapter 1 Product Information	1
1.1 Product Model Description	1
1.2 Product Nameplate Description	1
1.3 Product Series	1
1.4 Technical Specifications of Product	3
1.5 Product Component Name	6
1.6 Product Outline, Mounting Dimension, and Weight	6
1.7 Operation Panel Outline and Mounting Dimension	8
1.8 Pallet Outline and Mounting Dimension	9
1.9 Braking Resistor	9
Chapter 2 Mechanical Installation	11
2.1 Environment for Product Installation	11
2.2 Mounting Direction and Space	11
2.3 Removal and Mounting of Operation Panel and Cover	12
Chapter 3 Electrical Installation	16
3.1 Connection of the Inverter and Peripheral Devices	16
3.2 Description of Peripheral Electrical Devices	17
3.3 Models of Main Circuit Peripheral Devices	17
3.4 Product Terminal Configuration	19
3.5 Functions of Main Circuit Terminal	19
3.6 Attention for Main Circuit Wiring	20
3.7 Terminal Wiring	23
3.8 Functions of Control Circuit Terminals	25
3.9 Schematic Diagram of Control Board	27
3.10 Control Circuit Peripheral Devices	28
3.11 Description of Jumper Function	29
Chapter 4 Operation Panel	30
4.1 Introduction to Operation Panel	30
4.2 Descriptions of Indicators	30
4.3 Description of Keys on Operation Panel	31
4.4 Menu Style	33
4.5 Password Operation	37
4.6 Lock/Unlock Keys	38
4.7 Operation Panel Display and Key Operation	39
4.8 Operation Example	40
4.9 Running for the First Time	41

Chapter 5 Parameter List	42
5.1 Complete Parameter List	42
Chapter 6 Parameter Descriptions	59
6.1 Basic Function Parameters (Group P0)	59
6.2 Main and Auxiliary Reference Parameters (Group P1)	63
6.3 Key and Display Parameters (Group P2).....	66
6.4 Start/stop Parameters (Group P3).....	69
6.5 Multi-step Parameters (Group P4)	71
6.6 Multi-function Input Parameters (Group P5).....	73
6.7 Analog Reference Parameters (Group P6)	82
6.8 Multi-Function Output Parameters (Group P7)	85
6.9 Process PID Close Loop Parameters (Group P8).....	93
6.10 Motor Parameters (Group P9)	96
6.11 Control Parameters (Group PA)	99
6.12 Enhanced Function Parameters (Group Pb).....	104
6.13 Communication Parameters (Group PC)	109
6.14 Controlled by Manufacture Parameters 1 (Group PE)	112
6.15 Fault Record Parameters (Group d0).....	112
6.16 Product Identity Parameters (Group d1)	113
6.17 Use of Display Parameters (Group d2).....	114
6.18 Special Parameters for Constant Pressure Control (Group H0)	116
6.19 Special Parameters for EX-DT01 (Group H1)	118
6.20 Controlled by Manufacture Parameters 2 (Group A0)	120
6.21 Setting Process for Constant Pressure Control	120
Chapter 7 Troubleshooting	122
7.1 List of Fault and Alarm Information	122
7.2 Troubleshooting Procedures	127
7.3 FAQ.....	127
Chapter 8 Maintenance and Inspection	131
8.1 Daily Inspections.....	131
8.2 Periodic Maintenance	132
8.3 Component Replacement	132
8.4 Insulation Test	132
Appendix A Modbus Communication Protocol	134
Appendix B E5 Series Hardware Non-standard List	141
Appendix C EX-DT01 Digital Terminal Extension Card	142

Chapter 1 Product Information

1.1 Product Model Description

The digits and letters in the inverter model field on the nameplate indicate such information as the inverter series, input voltage, power, software version and hardware version.

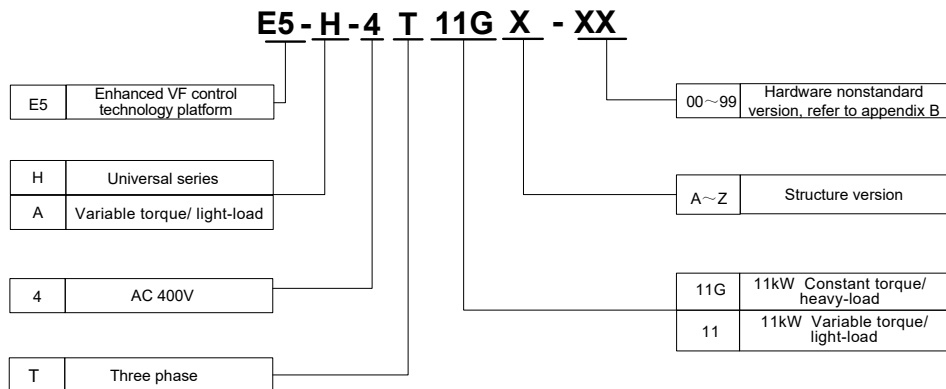

1.2 Product Nameplate Description

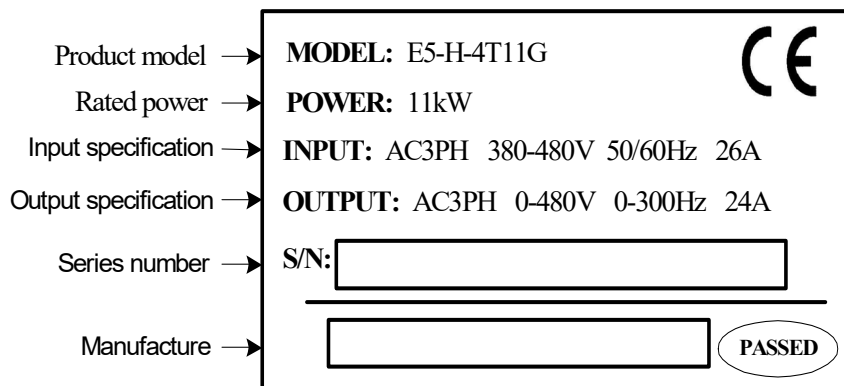

1.3 Product Series

■ E5-H-4T□□□G *¹ Three-phase 400V constant torque/heavy-load application

Power (kW)		0.75	1.5	2.2	3.7	5.5	7.5	11	15	18.5	22	30	37	45	55	75
Motor power (kW)		0.75	1.5	2.2	3.7	5.5	7.5	11	15	18.5	22	30	37	45	55	75
Output	Voltage (V)	Three-phase 0 to rated input voltage														
	Rated current (A)	2.5	3.8	5.5	9	13	17	24	30	39	45	60	75	91	112	150
	Overload capacity	150% 1 minute, 180% 10 seconds, 200% 0.5 second, interval: 10 minutes (inverse time lag feature)														
Input	Rated voltage/frequency	Three-phase 380V/480V; 50Hz/60Hz														
	Allowable voltage range	323V ~ 528V; voltage imbalance ≤3%; allowable frequency fluctuation: ±5%														
	Rated current (A)	2.8	4.2	6.1	10	15	19	26	33	43	50	66	83	100	123	165
Braking unit		Built-in as standard									External braking unit					
Protection class		IP20														
Cooling mode		Natural air cooling			Force air cooling											
Power (kW)		90	110	132	160	185	200	220	250	280	315	355	400	450	500	
Motor power (kW)		90	110	132	160	185	200	220	250	280	315	355	400	450	500	
Output	Voltage (V)	Three-phase 0 to rated input voltage														
	Rated current (A)	176	210	253	304	350	380	426	470	520	600	650	690	775	860	
	Overload capacity	150% 1 minute, 180% 10 seconds, 200% 0.5 second, interval: 10 minutes (inverse time lag feature)														
Input	Rated voltage/frequency	Three-phase 380V/480V; 50Hz/60Hz														
	Allowable voltage range	323V ~ 528V; voltage imbalance ≤3%; allowable frequency fluctuation: ±5%														
	Rated current (A)	No DC reactor	194	230	275	335	385	415	470	515	570	660	715	760	850	945
DC reactor * ²		160	196	232	282	326	352	385	437	491	580	624	670	755	840	
Braking unit		External braking unit														
Protection class		IP20														
Cooling mode		Force air cooling														

If higher power level inverter is required, please contact the manufacture.

Note:

- *¹ For 18.5kW to 75kW, the structure version is "A", for other power class, the structure version doesn't required to be shown for E5-H series.
- *² Rated input current when external DC reactor is installed.

■ E5-A-4T□□□^{*1} Three-phase 400V variable torque/light-load application

Power (kW)	15	18.5	22	30	37	45	55	75	90	110	132	
Motor power (kW)	15	18.5	22	30	37	45	55	75	90	110	132	
Output	Voltage (V)	Three-phase 0 to rated input voltage										
	Rated current (A)	29	35	45	57	70	91	110	144	180	216	242
Input	Overload capacity	120% 1 minute, 10 minutes (inverse time lag feature)										
	Rated voltage/frequency	Three-phase 380V/480V; 50Hz/60Hz										
	Allowable voltage fluctuation range	323V ~ 528V; voltage imbalance: ≤3%; allowable frequency fluctuation: ±5%										
	Rated current (A)	32	39	50	62	77	100	121	158	198	238	266
Braking unit	Built-in as standard		External braking unit									
Protection class	IP20											
Cooling mode	Forced air cooling											
Power (kW)	160	185	200	220	250	280	315	355	400	450		
Motor power (kW)	160	185	200	220	250	280	315	355	400	450		
Output	Voltage (V)	Three-phase 0 to rated input voltage										
	Rated current (A)	325	365	405	440	495	547	610	695	770	866	
	Overload capacity	120% 1 minute, 10 minutes (inverse time lag feature)										
Input	Rated voltage/frequency	Three-phase 380V/480V; 50Hz/60Hz										
	Allowable voltage range	323V ~ 528V; voltage imbalance ≤3%; allowable frequency fluctuation: ±5%										
	Rated current (A)	No DC reactor	358	402	446	484	545	600	670	765	845	950
DC reactor		282	326	352	385	437	491	580	670	755	840	
Braking unit	External braking unit											
Protection class	IP20											
Cooling mode	Forced air cooling											

If higher power level inverter is required, please contact the manufacture.

Note:

- ^{*1} The structure version doesn't required to be shown for E5-A series.
- ^{*2} Rated input current when external DC reactor is installed.

1.4 Technical Specifications of Product

Control characteristics	Control mode	Enhanced V/F control
	Starting torque	0.50Hz 180%
	Range of speed regulation	1:100
	Precision of steady speed	± 0.5%
Product functions	Key functions	Under-voltage regulation, switchover of run command source(operation panel, terminal and communication), speed tracing function, multi-step frequency reference(up to 23 step frequency), motor data identification, S curve acceleration and deceleration, slip compensation, PID regulation, droop control, current limit, manual torque boost and auto torque boost, programmable digital inputs, programmable digital outputs
	Frequency reference mode	Parameter setting, operation panel UP/DN, terminal, terminal UP/DN, communication, analog AI1, analog AI2,analog AI3, pulse DI, etc.
	Frequency range	0.00 ~ 300.00Hz
	Start frequency	0.00 ~ 60.00Hz
	Acceleration time and deceleration time	0.1 ~ 36000s
	Dynamic braking	Braking unit action voltage: 650 ~ 750V; operating time: 100.0s
	DC braking	DC braking start frequency: 0.00 ~ 300.00Hz DC braking current: constant torque: 0.0 ~ 120.0% variable torque: 0.0 ~ 90.0% DC braking time: 0.0 ~ 30.0s, DC braking function does not required waiting time to start to realize quick braking
Magnetic flux braking	Enabled or disabled during deceleration are optional, the default setting is enabled	
Unique functions	Multi-function M key	The unique multi-function key can be set to frequently used operations: such as JOG, emergency stop, switchover of run command source, switchover of parameters display mode, etc.
	Multiple parameter display modes	Basic parameters display mode, fast parameters display mode, non-factory setting parameters display mode, last changed 10 parameters display mode
	Parameters copy	The standard operation panel can realize the parameters upload, download and display the copy progress. Users can set to forbid overwriting the uploaded parameters
	Dual 485 communication ports	Dual 485 communication ports support Modbus protocol (RTU). The maximum distance is 500 meters
	Operation panel	Key type or shuttle type operation panel are optional Protection level: IP20 as standard, IP54 as option
	Common DC bus	All series product support common DC bus
	Independent duct	All series product adopts independent duct design and supports the installation of heat-sink outside the cabinet
Power-On-Self-Test (POST)	Realizing the POST of internal and peripheral circuits, including motor grounded, abnormal +10V power supply output, analog input and disconnection, etc.	

Protection function	Power supply under-voltage, over-current protection, over-voltage protection, interference protection, abnormal comparison level, motor data identification failure, module(IPM) protection, heat-sink over temperature protection, inverter overload protection, motor overload protection, peripheral protection, abnormal current detection, output short circuit to ground, interruption of power supply when in running status, abnormal input power, output phase loss, abnormal EEPROM protection, abnormal pre-charging contactor detection, temperature sampling disconnection, abnormal +10V power supply, abnormal analog input, motor over temperature protection(PTC), abnormal communication, abnormal software version compatibility, abnormal copying, terminal mutual exclusion detection, hardware overload protection	
Efficiency	At rated power: E5-H series: 7.5kW and below power class ≥93% 45kW and below power class ≥95% 55kW and above power class ≥98% E5-A series: 55kW and below power class ≥95% 75kW and above power class ≥98%	
Environment	Operating site	The product should be mounted vertically in the electric control cabinet with good ventilation. Horizontal or other installation modes are not allowed. The cooling medium is the air. The product should be installed in the environment without dust, corrosive gas, combustible gas, oil mist, steam, drip and free from direct sunlight
	Ambient temperature	-10 to +40°C, the product must be de-rated rated output current for the ambient temperature between 40°C to 50°C, the rated output current must be de-rated for 1% per 1°C temperature rise
	Humidity	5 to 95%, no condensing
	Altitude	0 to 2000m, the product must be de-rated rated output current for the altitude above 1000 meters, the rated output current must be de-rated for 1% per 100 meters rise
	Vibration	3.5m/s ² ,2 to 9Hz; 10 m/s ² ,9 to 200Hz; 15 m/s ² ,200 to 500Hz
	Storage temperature	-40 to +70°C

Note:

AI3 and terminal 485 are only available for "E5-H-4T**G-63", "E5-H-4T**G-34" non-standard series and E5-A series

1.5 Product Component Name

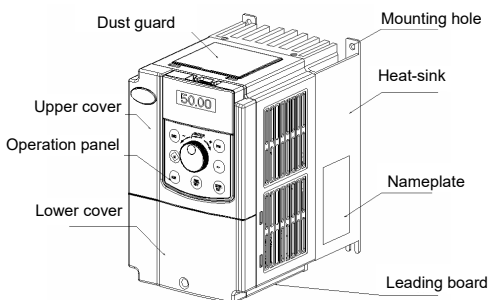

E5-H-4T7.5G and below power class

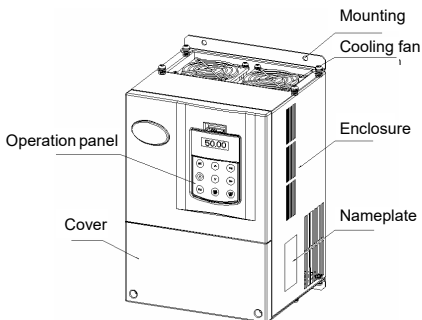

E5-H-4T11G and above power class
E5-A-4T15 and above power class

Figure 1-1 Product component name

1.6 Product Outline, Mounting Dimension, and Weight

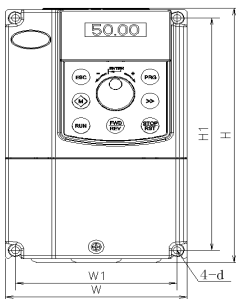

E5-H-4T7.5G and below power class

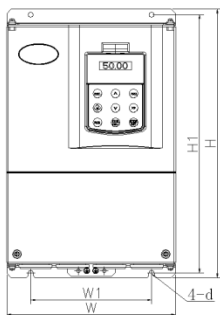
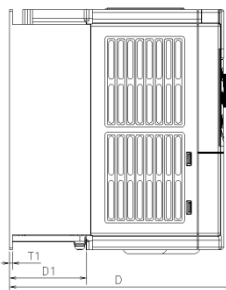

E5-H-4T11G and above power class, E5-A-4T15 and above power class

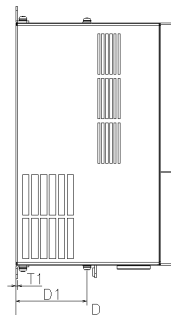

Figure 1-2 Product outline and mounting dimension

1.6.1 E5-H Product outline, mounting dimension, and weight

Voltage	Model	Outline and mounting dimension (mm)								Approximate weight (kg)
		W	H	D	W1	H1	D1	T1	Mounting hole diameter	
400V	E5-H-4T0.75G	118	190	155	105	173	40.8	3	5.5	1.5
	E5-H-4T1.5G	118	190	175	105	173	60.5	4	5.5	2.6
	E5-H-4T2.2G									
	E5-H-4T3.7G									
	E5-H-4T5.5G	155	249	185	136	232	69	8	5.5	3
	E5-H-4T7.5G									
	E5-H-4T11G	210	337	200	150	324	107.5	2.5	7	8.5
	E5-H-4T15G									
	E5-H-4T18.5GA	285	440	220	200	425	107.5	2.5	7	17
	E5-H-4T22GA									
	E5-H-4T30GA									
	E5-H-4T37GA	315	575	227	220	553	123.5	2.5	10	25
	E5-H-4T45GA									
	E5-H-4T55GA	400	615	265	270	590	123.5	3.0	10	35
	E5-H-4T75GA									
	E5-H-4T90G	465	745	325	343	715	156	3.0	12	55
	E5-H-4T110G									
	E5-H-4T132G	540	890	385	370	855	205.5	4.0	14	85
	E5-H-4T160G									
	E5-H-4T185G									
	E5-H-4T200G									
	E5-H-4T220G	700	1010	385	520	977	210	4.0	14	125
	E5-H-4T250G									
E5-H-4T280G										
E5-H-4T315G	810	1358	425	520	1300	210	4.0	14	215	
E5-H-4T355G										
E5-H-4T400G										
E5-H-4T450G										
E5-H-4T500G										
E5-H-4T500G										

1.6.2 E5-A Product outline, mounting dimension, and weight

Voltage	Model	Outline and mounting dimension (mm)								Approximate weight (kg)
		W	H	D	W1	H1	D1	T1	Mounting hole diameter	
400V	E5-A-4T15	210	337	200	150	324	107.5	2.5	7	8.5
	E5-A-4T18.5									
	E5-A-4T22	285	440	220	200	425	107.5	2.5	7	17
	E5-A-4T30									
	E5-A-4T37									
	E5-A-4T45	315	575	227	220	553	123.5	2.5	10	25
	E5-A-4T55									
	E5-A-4T75	400	615	265	270	590	123.5	3.0	10	35
	E5-A-4T90									
	E5-A-4T110	465	745	325	343	715	151.5	3.0	12	55
	E5-A-4T132									
	E5-A-4T160	540	890	385	370	855	205.5	4.0	14	85
	E5-A-4T185									
	E5-A-4T200									
	E5-A-4T220									
	E5-A-4T250	700	1010	385	520	977	210	4.0	14	125
	E5-A-4T280									
	E5-A-4T315									
	E5-A-4T355	810	1358	425	520	1300	210	4.0	14	215
E5-A-4T400										
E5-A-4T450										
E5-A-4T450										

1.7 Operation Panel Outline and Mounting Dimension

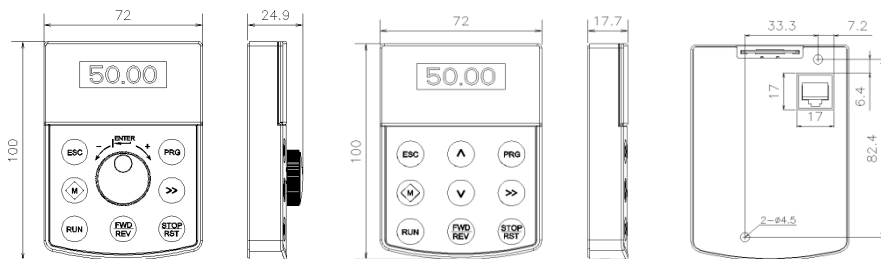

Shuttle type operation panel (V6-DP01) Key type operation panel (V6-DP02) Rear view of operation panel

Figure1-3 Operation panel outline and mounting dimension

Note:

- E5-H-4T7.5G and below power class: Equipped with V6-DP01 as standard.
- E5-H-4T11G and above power class: Equipped with V6-DP02 as standard.
- E5-A-4T15 and above power class: Equipped with V6-DP02 as standard.

1.8 Pallet Outline and Mounting Dimension

V6-DP05 is the mounting pallet when the operation panel is to install on the external electric control cabinet. The outline and dimension are as follows:

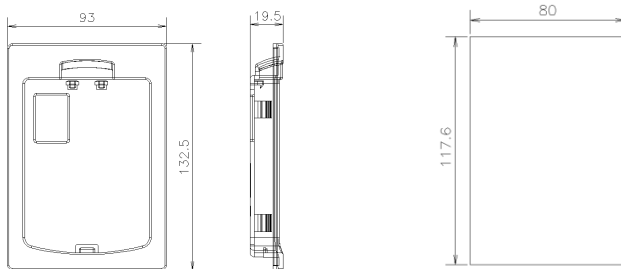

Pallet (V6-DP05)

Open pore dimension of pallet

Figure1-4 Pallet outline and mounting dimension

1.9 Braking Resistor

Inverter model	Braking unit	Braking resistor (10% ED, Max. 10s)				Braking torque%
		Power	Resistor	Minimum resistance of braking resistor	Qty.	
E5-H-4T0.75G	Built-in as standard	110W	750Ω	125Ω	1	130
E5-H-4T1.5G		260W	400Ω	100Ω	1	125
E5-H-4T2.2G		320W	250Ω	100Ω	1	135
E5-H-4T3.7G		550W	150Ω	66.7Ω	1	135
E5-H-4T5.5G		800W	100Ω	66.7Ω	1	135
E5-H-4T7.5G		1070W	75Ω	66.7Ω	1	130
E5-H-4T11G		1600W	50Ω	25Ω	1	135
E5-A-4T15		2000W	40Ω	25Ω	1	125
E5-H-4T15G						
E5-A-4T18.5						

Note:

- The braking resistor must not be lower than minimum resistance, otherwise, the built-in braking unit may be damaged.
- The table is for a reference only. Actual braking resistor resistance and power should be determined by motor generation power, system inertia, deceleration time and potential energy, etc.

Chapter 2 Mechanical Installation

2.1 Environment for Product Installation

- Do not install the inverter in the sites with oil mist, metal powder and dust.
- Do not install the inverter in the sites with hazardous gas and liquid, and corrosive, combustible and explosive gas.
- Do not install the inverter in salty sites.
- Do not install the inverter in the sites with direct sunlight.
- Do not mount the inverter on the combustible materials, such as wood.
- Keep the drilling scraps away from the inverter during the installation.
- Mount the inverter vertically in the electric control cabinet, mount the cooling fan or air conditioner to prevent the ambient temperature from rising to above 45 °C.
- For the sites with adverse environment, it is recommended to mount the inverter heat-sink outside the cabinet.

2.2 Mounting Direction and Space

For excellent cooling effect, the inverter must be mounted vertically, and certain clearance must be maintained, as shown in the following figure.

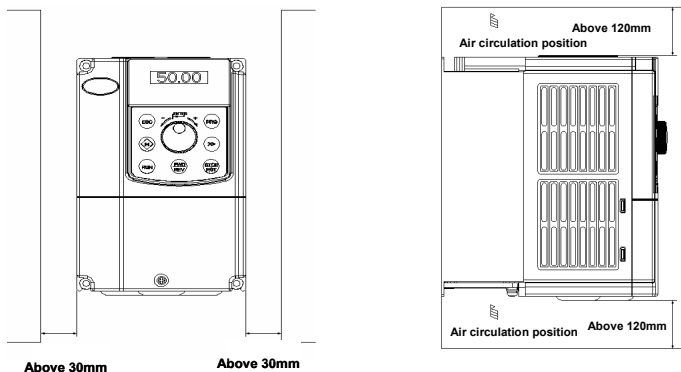

Figure2-1 Mounting direction and space for E5-H-4T7.5G and below power class



Note:

When the E5-H-4T7.5G and below power class inverters are mounted side by side in the cabinet, please remove the upper dust guard and the lower leading board.

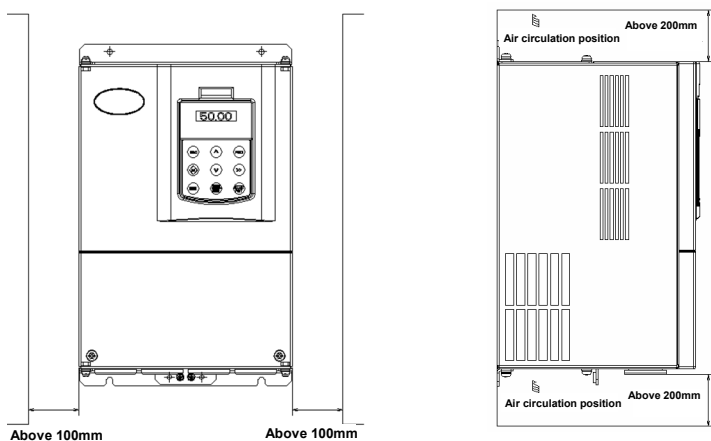

Figure 2-2 Mounting direction and clearance for E5-H-4T11G / E5-A-4T15 and above power class

2.3 Removal and Mounting of Operation Panel and Cover

2.3.1 Removal and Mounting of Operation Panel

◆ Removal of operation panel

As shown in Figure 2-3, the grab on the operation panel forcefully in direction 1, and then lift the panel body in direction 2.

◆ Mounting of operation panel

As shown in Figure2-4, align with the lower clamping position of the operation panel in direction 1, and then press down the operation panel in direction 2, until the “crack” sound is heard.

Do not mount the operation panel in any other direction; otherwise, the operation panel will have poor contact.

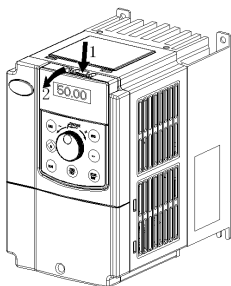

Figure 2-3 Removal of operation panel

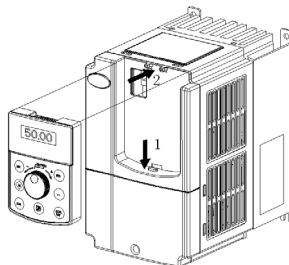

Figure2-4 Mounting of operation panel

2.3.2 Removal and Mounting of Covers with Plastic Enclosure

- ◆ Removal of operation panel

Please refer to 2.3.1 Removal and Mounting of Operation Panel.

- ◆ Removal of lower cover

After removing the mounting screws of the cover, press the left and right sides of the cover forcefully in direction 1 and lift the cover in direction 2 simultaneously, as shown in Figure 2-5.

- ◆ Removal of upper cover

As shown in Figure2-6, press the left and right sides of the cover forcefully in direction 1, and lift the cover in direction 2 simultaneously.

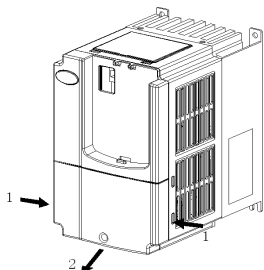

Figure 2-5 Removal of lower cover

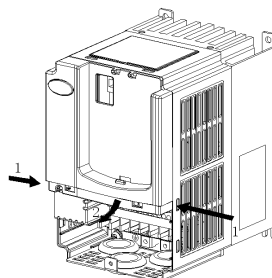

Figure 2-6 Removal of high cover

- ◆ Mounting upper cover

After connecting the cables of main circuit terminals and control circuit terminals, insert the upper claw grab of the upper cover into the groove of the inverter body, as shown in position 1 in Figure2-7, and then press the lower part of the upper cover in direction 2 as shown in Figure2-7, until the “crack” sound is heard.

- ◆ Mounting lower cover

Insert the upper claw grab on the lower cover into the groove of the upper cover, as shown in position 1 of Figure2-8, and then press the lower part of the lower cover in direction 2 of Figure2-8, until the “crack” sound is heard. Now, tighten the cover screws.

- ◆ Mounting operation panel

Please refer to 2.3.1 Removal and Mounting of Operation Panel.

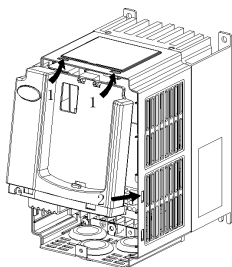

Figure2-7 Mounting of upper cover

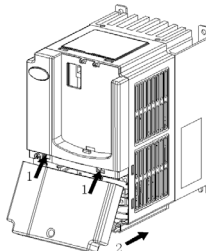

Figure2-8 Mounting of lower cover

2.3.3 Removal and Mounting of Covers with Sheet-metal Enclosure:

E5-H-4T11G, E5-H-4T15G, E5-H-4T18.5GA ~ E5-H-4T75GA
E5-A-4T15 ~ E5-A-4T90

◆ Removal of operation panel

Please refer to 2.3.1 Removal and Mounting of Operation Panel.

◆ Removal cover

Remove the mounting screws on the lower part of the cover, lift the cover in direction 1 as shown in Figure2-9, and then take out the cover in direction 2.

◆ Mounting cover

After connecting the cables of the main circuit terminals and control circuit terminals, cramp the cover in direction 1 as shown in Figure2-10, press down the cover in direction 2 and then tighten the cover screws.

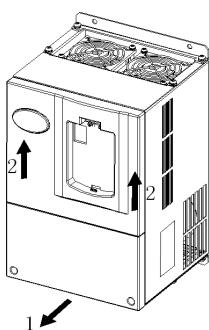

Figure2-9 Removal of cover

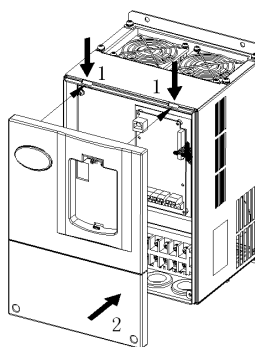

Figure2-10 Mounting of cover

◆ Mounting operation panel

Please refer to 2.3.1 Removal and Mounting of Operation Panel.



Note:

Do not directly mount the cover with operation panel; otherwise, the operation panel will have poor contact.

2.3.4 Open and Close of Doors with Sheet-metal Enclosure:

E5-H-4T90G and Above Power Class

E5-A-4T110 and Above Power Class

◆ Opening of the door

Press the latch following direction 1 in Figure2-11 and open the door following direction 2.

◆ Removal of operation panel

The operation panel is connected to the control board through the standard network cable and will not interfere with the open/close of the door. To remove the operation panel, refer to 2.3.1 Removal and Mounting of Operation Panel

◆ Mounting of cover

After the wiring operation of main circuit terminals and control circuit terminals is completed, close the door following direction 1 in Figure2-12, and then press down the latch following direction 2 to lock the door.

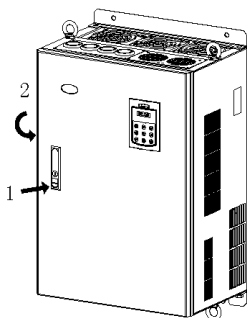

Figure 2-11 Opening the door

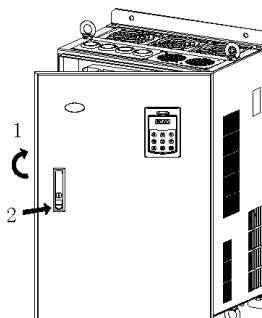

Figure 2-12 Closing the door

Chapter 3 Electrical Installation

3.1 Connection of the Inverter and Peripheral Devices

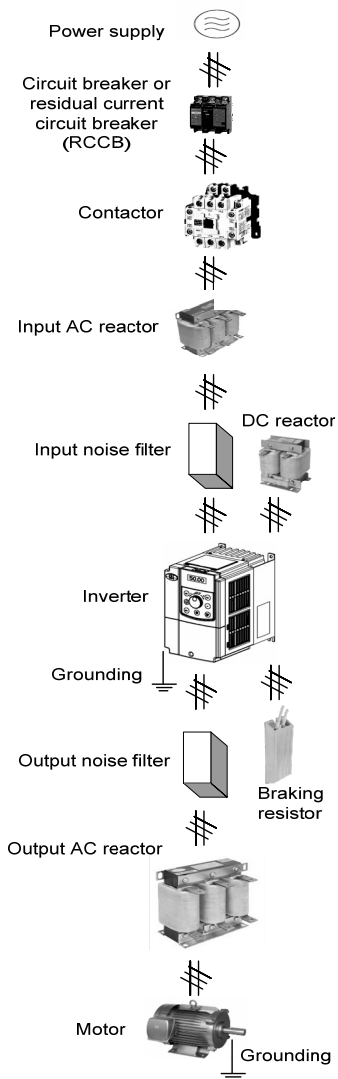

Figure3-1 Connection diagram of the product and peripheral devices

3.2 Description of Peripheral Electrical Devices

Circuit breaker	The circuit breaker capacity should be 1.5 ~ 2 times of the inverter rated current. The time features of the circuit breaker should fully consider the time features of the inverter overload protection.
RCCB (Residual current circuit breaker)	The inverter output is the high-frequency pulse and also generates leakage currents to ground. Special RCCB shall be used when installing RCCB at the input end of the inverter. It is suggested that B type RCCB should be used, and the leakage current value shall be set to 300mA.
Contactor	Frequent contactor action will cause inverter failure, so the highest frequency for the open and close of contactor shall not exceed 10 times/min. When braking resistor is used, to avoid the over-temperature damage of the braking resistor, a thermal protection relay with braking resistor over-temperature detection should be installed to disconnect the contactor of power supply.
Input AC reactor or DC reactor	<ol style="list-style-type: none"> 1. The inverter power supply capacity is more than 600kVA or 10 times of the inverter capacity. 2. If there is switch type reactive-load compensation capacitor or load with silicon control at the same power node, there will be high peak current flowing into input power circuit, which damage the rectifier components. 3. When the voltage imbalance of the three-phase power supply of the inverter exceeds 3%, the rectifier component will be damaged. 4. It is required that the input power factor of the inverter shall be higher than 90%. 5. When exists the above situations, the AC reactor at the inverter input side or DC reactor to the DC reactor terminal should be installed.
Input noise filter	Reduce external conduction and radiation interference of the inverter. Decrease conduction interference flowing from power supply and improve the anti-interference capacity.
Thermal protection relay	Although the inverter has motor overload protection function, when one inverter drives two or more motors or multi-pole motors, to prevent the motor over temperature, thermal protection relay shall be installed between the inverter and each motor, and the motor overload protection parameter P9.16 shall be set to "2" (motor protection disabled).
Output noise filter	When the output end of the inverter is connected with noise filter, the conduction and radiation interference can be reduced.
Output AC reactor	When the cable connecting the inverter and the motor is longer than 100m, it is suggested to install AC output reactor to suppress the high-frequency oscillation to avoid damaging motor insulation, large leakage current and frequent inverter protective action.

3.3 Models of Main Circuit Peripheral Devices

3.3.1 E5-H Models of Main Circuit Peripheral Devices

Inverter model	Circuit Breaker (A)	Contactor (A)	R/L1, S/L2, T/L3, ⊕1, ⊕2/B1, B2, ⊖, U/T1, V/T2, W/T3			PE terminal ⊕		
			Terminal screw	Tightening torque (N·m)	Wire specification (mm ²)	Terminal screw	Tightening torque (N·m)	Wire specification (mm ²)
E5-H-4T0.75G	10	10	M4	1.2 ~ 1.5	2.5	M4	1.2 ~ 1.5	2.5
E5-H-4T1.5G	16	10	M4	1.2 ~ 1.5	2.5	M4	1.2 ~ 1.5	2.5
E5-H-4T2.2G	16	10	M4	1.2 ~ 1.5	2.5	M4	1.2 ~ 1.5	2.5
E5-H-4T3.7G	25	16	M4	1.2 ~ 1.5	4	M4	1.2 ~ 1.5	4
E5-H-4T5.5G	32	25	M4	1.2 ~ 1.5	6	M4	1.2 ~ 1.5	6
E5-H-4T7.5G	40	32	M4	1.2 ~ 1.5	6	M4	1.2 ~ 1.5	6
E5-H-4T11G	63	40	M5	2.5 ~ 3.0	6	M5	2.5 ~ 3.0	6
E5-H-4T15G	63	63	M5	2.5 ~ 3.0	6	M5	2.5 ~ 3.0	6
E5-H-4T18.5GA	100	63	M6	4.0 ~ 5.0	10	M6	4.0 ~ 5.0	10
E5-H-4T22GA	100	100	M6	4.0 ~ 5.0	16	M6	4.0 ~ 5.0	16
E5-H-4T30GA	125	100	M6	4.0 ~ 5.0	25	M6	4.0 ~ 5.0	16
E5-H-4T37GA	160	100	M8	9.0 ~ 10.0	25	M8	9.0 ~ 10.0	16
E5-H-4T45GA	200	125	M8	9.0 ~ 10.0	35	M8	9.0 ~ 10.0	16
E5-H-4T55GA	315	250	M10	17.6 ~ 22.5	50	M10	14.0 ~ 15.0	25
E5-H-4T75GA	350	330	M10	17.6 ~ 22.5	60	M10	14.0 ~ 15.0	35
E5-H-4T90G	315	250	M10	17.6 ~ 22.5	70	M10	14.0 ~ 15.0	35
E5-H-4T110G	400	330	M10	17.6 ~ 22.5	100	M10	14.0 ~ 15.0	50
E5-H-4T132G	500	400	M12	31.4 ~ 39.2	150	M12	17.6 ~ 22.5	75
E5-H-4T160G	630	400	M12	31.4 ~ 39.2	185	M12	17.6 ~ 22.5	50×2
E5-H-4T185G	630	500	M12	48.6 ~ 59.4	240	M12	31.4 ~ 39.2	60×2
E5-H-4T200G	800	500	M12	48.6 ~ 59.4	240	M12	31.4 ~ 39.2	60×2
E5-H-4T220G	800	630	M12	48.6 ~ 59.4	150×2	M12	31.4 ~ 39.2	75×2
E5-H-4T250G	1000	630	M12	48.6 ~ 59.4	185×2	M12	31.4 ~ 39.2	100×2
E5-H-4T280G	1000	630	M12	48.6 ~ 59.4	185×2	M12	31.4 ~ 39.2	100×2
E5-H-4T315G	1000	800	M14	48.6 ~ 59.4	250×2	M14	31.4 ~ 39.2	125×2
E5-H-4T355G	1200	800	M14	48.6 ~ 59.4	325×2	M14	31.4 ~ 39.2	150×2
E5-H-4T400G	1500	1000	M14	48.6 ~ 59.4	325×2	M14	31.4 ~ 39.2	150×2
E5-H-4T450G	2000	1500	M14	48.6 ~ 59.4	350×2	M14	31.4 ~ 39.2	175×2
E5-H-4T500G	2000	1500	M14	48.6 ~ 59.4	350×2	M14	31.4 ~ 39.2	175×2

3.3.2 E5-A Models of Main Circuit Peripheral Devices

Inverter model	Circuit breaker (A)	Contactor (A)	R/L1, S/L2, T/L3, ⊕1, ⊕2/B1, B2, ⊖, U/T1, V/T2, W/T3			PE terminal ⊕		
			Terminal screw	Tightening torque (N·m)	Wire specification (mm ²)	Terminal screw	Tightening torque (N·m)	Wire specification (mm ²)
E5-A-4T15	63	40	M5	2.5 ~ 3.0	6	M5	2.5 ~ 3.0	6
E5-A-4T18.5	63	63	M5	2.5 ~ 3.0	6	M5	2.5 ~ 3.0	6
E5-A-4T22	100	63	M6	4.0 ~ 5.0	10	M6	4.0 ~ 5.0	10
E5-A-4T30	100	100	M6	4.0 ~ 5.0	16	M6	4.0 ~ 5.0	16
E5-A-4T37	125	100	M6	4.0 ~ 5.0	25	M6	4.0 ~ 5.0	16
E5-A-4T45	160	100	M8	9.0 ~ 10.0	25	M8	9.0 ~ 10.0	16
E5-A-4T55	200	125	M8	9.0 ~ 10.0	35	M8	9.0 ~ 10.0	16
E5-A-4T75	315	250	M10	17.6 ~ 22.5	50	M10	14.0 ~ 15.0	25
E5-A-4T90	350	330	M10	17.6 ~ 22.5	60	M10	14.0 ~ 15.0	35
E5-A-4T110	400	330	M10	17.6 ~ 22.5	100	M10	14.0 ~ 15.0	35
E5-A-4T132	500	400	M10	17.6 ~ 22.5	150	M10	14.0 ~ 15.0	50
E5-A-4T160	630	500	M12	31.4 ~ 39.2	185	M12	17.6 ~ 22.5	75
E5-A-4T185	630	500	M12	31.4 ~ 39.2	240	M12	17.6 ~ 22.5	50×2
E5-A-4T200	800	630	M12	48.6 ~ 59.4	240	M12	31.4 ~ 39.2	60×2
E5-A-4T220	800	630	M12	48.6 ~ 59.4	150×2	M12	31.4 ~ 39.2	60×2
E5-A-4T250	1000	630	M12	48.6 ~ 59.4	185×2	M12	31.4 ~ 39.2	75×2
E5-A-4T280	1000	630	M12	48.6 ~ 59.4	185×2	M12	31.4 ~ 39.2	100×2
E5-A-4T315	1000	800	M12	48.6 ~ 59.4	185×2	M12	31.4 ~ 39.2	100×2
E5-A-4T355	1200	800	M14	48.6 ~ 59.4	250×2	M14	31.4 ~ 39.2	125×2
E5-A-4T400	1500	1000	M14	48.6 ~ 59.4	325×2	M14	31.4 ~ 39.2	150×2
E5-A-4T450	2000	1500	M14	48.6 ~ 59.4	325×2	M14	31.4 ~ 39.2	150×2

3.4 Product Terminal Configuration

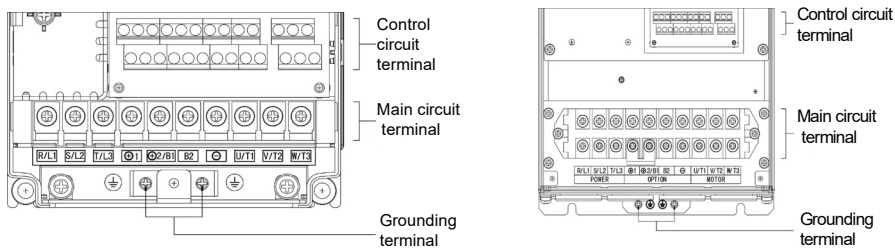

E5-H-4T7.5G and below power class

E5-H-4T11G and above power class

E5-A-4T15 and above power class

Figure3-2 Product terminal configuration

3.5 Functions of Main Circuit Terminal

3.5.1 E5-H-4T0.75G ~ E5-H-4T15G and E5-A-4T1.5 ~ E5-A-4T18.5

R/L1	S/L2	T/L3	+1	+2/B1	B2	—	U/T1	V/T2	W/T3
POWER			OPTION			MOTOR			



Terminal symbol	Terminal name and function description
R/L1, S/L2, T/L3	Three-phase AC input terminal
⊕1, ⊕2/B1	DC reactor connecting terminal, short circuited with copper bus by default
⊕2/B1, B2	Connecting terminal of braking resistor
⊕2/B1, ⊖	DC power input terminal; DC input terminal of external braking unit
U/T1, V/T2, W/T3	Three-phase AC output terminal
⊕	Grounding terminal PE

3.5.2 E5-H-4T18.5GA ~ E5-H-4T75GA and E5-A-4T22 ~ E5-A-4T90

R/L1	S/L2	T/L3	+1	+2	—	U/T1	V/T2	W/T3
POWER			OPTION			MOTOR		

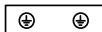

Terminal symbol	Terminal name and function description
R/L1, S/L2, T/L3	Three-phase AC input terminal
⊕1, ⊕2	DC reactor connecting terminal, short circuited with copper bus by default
⊕2, ⊖	DC power input terminal; DC input terminal of external braking unit
U/T1, V/T2, W/T3	Three-phase AC output terminal
⊕	Grounding terminal PE

3.5.4 E5-H-4T90G ~ E5-H-4T500G and E5-A-4T110 ~ E5-A-4T450

Adopt the top connect power supply, bottom connect DC bus and motor.

POWER		
R/L1	S/L2	T/L3



+1	+2	—
OPTION		



U/T1	V/T2	W/T3
MOTOR		

Terminal symbol	Terminal name and function description
R/L1, S/L2, T/L3	Three-phase AC input terminal
⊕1, ⊕2	DC reactor connecting terminal, if without DC reactor, the inverter will not display after power on.
⊕2, ⊖	DC power input terminal; External braking unit
U/T1, V/T2, W/T3	Three-phase AC output terminal
⊕	Grounding terminal PE

3.6 Attention for Main Circuit Wiring

3.6.1 Power Supply Wiring

- ◆ It is forbidden to connect the three phase power supply cable to the inverter output terminals; otherwise, the internal components of the inverter will be damaged.
- ◆ The inverter shall connect to the power supply through a circuit breaker or RCCB and contactor to protect the inverter input against over current or disconnects the input power for maintenance.
- ◆ Please confirm that the power supply phases, rated input voltage are consistent with the nameplate, otherwise, the inverter may be damaged.

3.6.2 Motor Wiring

- ◆ It is forbidden to short circuit the inverter output terminals or short circuit to ground, otherwise the internal components of the inverter will be damaged.
- ◆ Do not short circuit the output cable to the inverter enclosure, otherwise electric shock may happen.
- ◆ It is forbidden to connect the output terminal of the inverter to the capacitor or LC/RC noise filter with phase lead, otherwise, the internal components of the inverter may be damaged.
- ◆ When contactor is installed between the inverter and motor, it is forbidden to switch on/off the contactor when the inverter is running; otherwise, large current will flow into the inverter, triggering the inverter protection action.
- ◆ Length of cable between the inverter and motor. If the cable between the inverter and the motor is too long, the high-order harmonic leakage current of the output end will cause adverse impact on the inverter and the peripheral devices. Output AC reactor should be installed if the motor cable is longer than 100m, Refer to the following table for the switching frequency setting.

Length of cable between inverter and motor	$\leq 50\text{m}$	$\leq 100\text{m}$	$> 100\text{m}$
Switching frequency (PA.00)	$< 15\text{kHz}$	$< 10\text{kHz}$	$< 5\text{kHz}$

3.6.3 Grounding Wiring

- ◆ The inverter will produce leakage current. The higher the switching frequency is, the larger the leakage current will be. The leakage current of the inverter system is more than 3.5mA, and the specific value of the leakage current is determined by the application conditions. To ensure the safety, the inverter and the motor must be grounded.
- ◆ The grounding resistance shall be less than 10 ohm. For the grounding wire diameter requirement, refer to 3.3 models of main circuit peripheral devices.
- ◆ Do not share grounding wire with the welding machine and other power equipment.
- ◆ In the applications with more than 2 inverters, keep the grounding wire away from forming a loop.



Figure 3-3 Grounding wiring

3.6.4 Countermeasures for Conduction and Radiation Interference

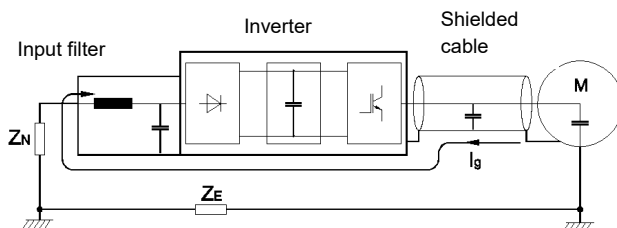

Figure3-4 Noise current illustration

- ◆ When the input noise filter is installed, the wire connecting the filter to the inverter input power terminals shall be as short as possible.
- ◆ The filter enclosure and mounting cabinet shall be reliably connected in large area to reduce the back flow impedance of the noise current I_q .
- ◆ The wire connecting the inverter and the motor shall be as short as possible. The motor cable adopts 4-core cable, with the grounding end grounded at the inverter side, the other end connected to the motor enclosure. The motor cable shall be sleeved into the metal tube.
- ◆ The input power wire and output motor wire shall be kept away from each other as long as possible.
- ◆ The equipment and signal cables vulnerable to influence shall be kept far away from the inverter.
- ◆ Main signal cables shall adopt shielded cable. It is suggested that the shielded layer shall be grounded with 360-degree grounding method and sleeved into the metal tube. The signal cable shall be kept far away from the inverter input wire and output motor wire. If the signal cable must cross the input wire and output motor wire, they shall be kept orthogonal.
- ◆ When frequency reference is analog voltage or current signals, shielded twisted pair cable shall be used. The shielded layer shall be connected to the PE terminal of the inverter, and the signal cable length should be less than 50m.
- ◆ The wires of the control circuit terminals RA/RB/RC and other control circuit terminals shall be separately routed.
- ◆ It is forbidden to short circuit the shielded layer and other signal cables or equipment.
- ◆ When the inverter is connected to the inductive load equipment (e.g. electromagnetic contactor, relay and solenoid valve), surge suppressor must be installed on the load equipment coil, as shown in the following figure.

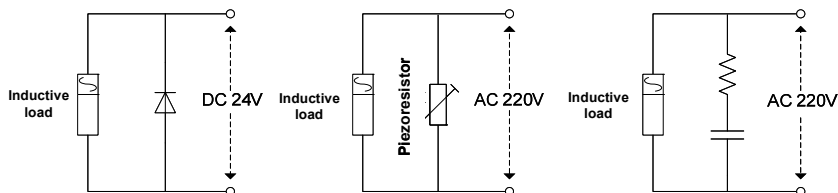

Figure3-5 Application of inductive load surge suppressor

3.7 Terminal Wiring

3.7.1 E5-H

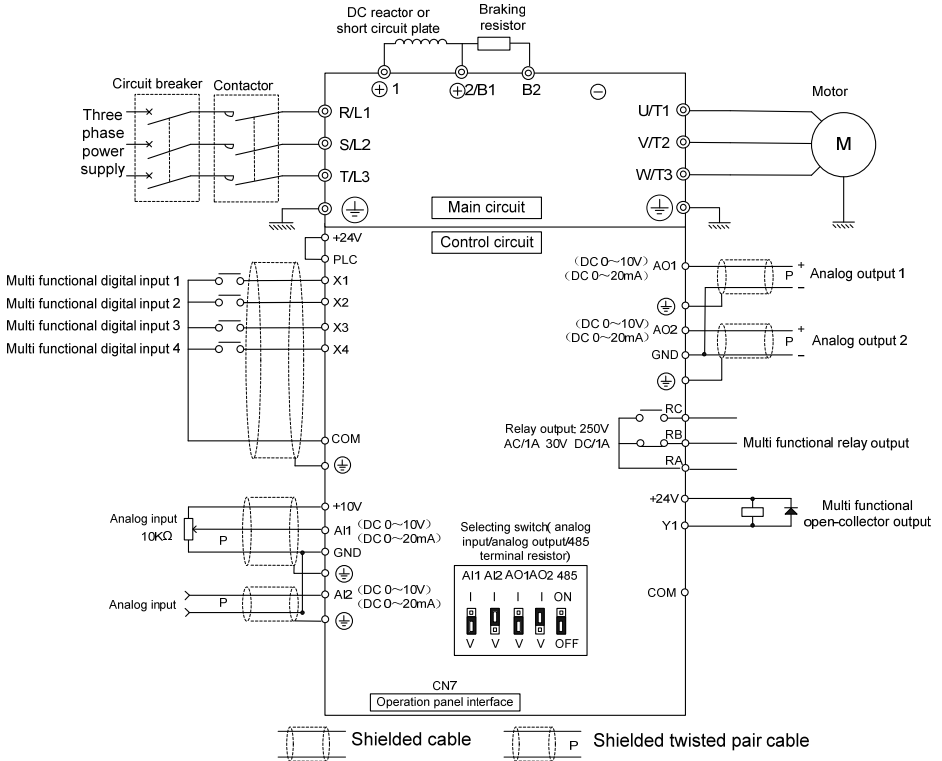

Figure3-6 Terminal wiring diagram (take E5-H-4T5.5G as an example)

3.7.2 E5-A / E5-H-34 / E5-H-63

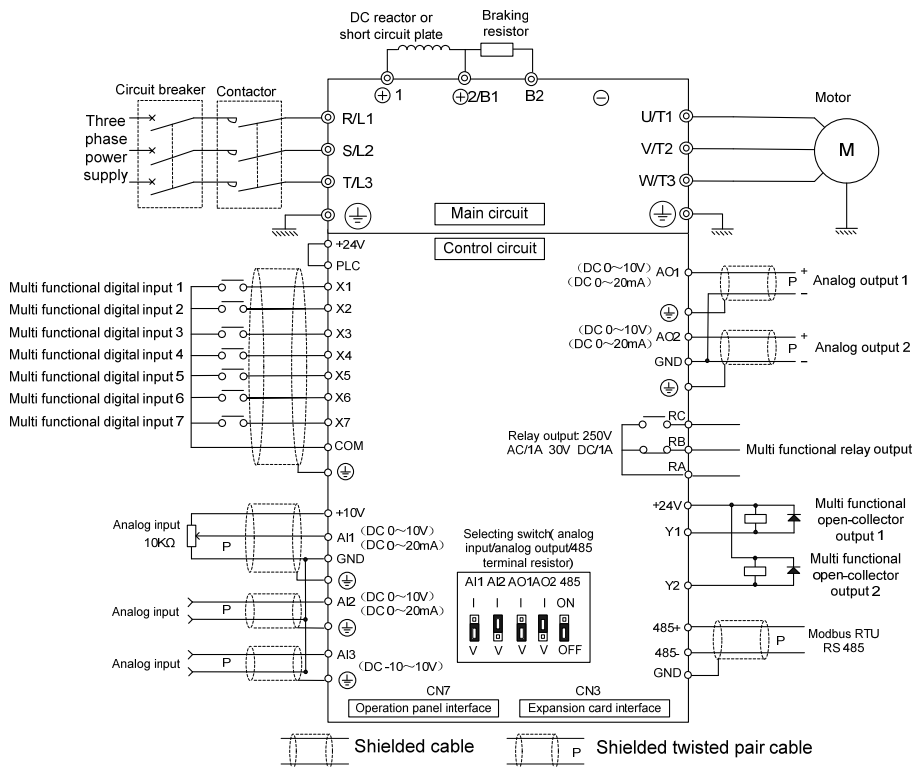

Figure3-7 Terminal wiring diagram (take E5-H-4T5.5G-34 as an example)

3.8 Functions of Control Circuit Terminals

3.8.1 E5-H

Type	Terminal symbol	Terminal function description	Technical specification
Operation panel RS485	CN7	RS485 port of operation panel	Rate: 38400bps Up to 32 sets of equipment can be paralleled. Relay shall be used if the number exceeds 32.
			The maximum distance is 15m for the communication connection of operation panel. (Adopt standard twisted non-shielded network cable)
Digital input	+24V	+24V	24V±10%, internal isolated with GND Maximum output current: 200mA, with overload and short circuit protection
	PLC	Power supply of multi-function digital input terminal	Short circuited with +24V by default.
	X1 ~ X4	Multi-function digital input terminals 1 ~ 4	Input specification: 24VDC,5mA Frequency range: 0 ~ 200Hz Voltage range: 24V±20%
	COM	Ground terminal for +24V	Internal isolated with GND
Digital output	Y1	Open collector output	Voltage range: 24V±20%, maximum input current: 50mA
	COM	Open collector output common end	Internal isolated with GND
Analog input	+10V	Analog input reference voltage	10V ±3%, internal isolated with COM Maximum output current: 10mA, with short circuit and overload protection
	AI1	Analog input channel 1	0 ~ 20mA: input impedance 500Ω maximum input current: 30mA 0 ~ 10V: input impedance 20kΩ maximum input voltage: 15V Resolution: 12 bits (0.025%) 0 ~ 20mA or 0 ~ 10V analog input can be selected through jumper
	AI2	Analog input channel 2	Same as AI1
	GND	Analog ground terminal	Internal isolated with COM If connects adjustable potentiometer between +10V and GND, the resistance of the potentiometer shall be more than 5kΩ
Analog output	AO1	Analog output 1	0 ~ 20mA: allowable output impedance 200 ~ 500Ω 0 ~ 10V: allowable output impedance ≥10kΩ Output precision: 2%, resolution: 10 bits (0.1%) with short circuit protection 0 ~ 20mA or 0 ~ 10V analog output can be selected through jumper
	AO2	Analog output 2	Same as AO1
	GND	Analog ground terminal	Internal isolated with COM
Relay output	RA/RB/RC	Relay output	RA-RB: normally closed RA-RC: normally open Contact capacity: 250VAC/1A, 30VDC/1A

Note:

The arrangement sequence of the control circuit terminals is as follows:

+10V	AI1	AI2		GND	AO1	AO2
+24V	PLC	COM	X1	X2	X3	X4

RA	RB	RC
Y1		COM

3.8.2 E5-A / E5-H-34 / E5-H-63

Type	Terminal	Description	Technical specification
Terminal RS485	RS485+	Positive end of RS485	Rate: 4800/9600/19200/38400/57600bps Up to 32 sets of equipment can be paralleled. Relay shall be used if the number exceeds 32 Maximum distance: 500m
	RS485-	Negative end of RS485	
	GND	Ground terminal of RS485 shielding layer	
Operation panel RS485	CN7	RS485 port of operation panel	The maximum distance between the operation panel and the operation panel interface is 15 meters (adopt standard twisted non-shielded network cable)
Digital input	+24V	+24V	24V±10%, internal isolated with GND Maximum output current: 200mA, with overload and short circuit protection
	PLC	Power supply of multi-function digital input terminal	Short circuited with +24V by default
	X1 ~ X6	Multi-function digital input terminals 1 ~ 6	Input specification: 24VDC, 5mA Frequency range: 0 ~ 200Hz Voltage range: 24V±20%
	X7/DI	Multi-function digital input or pulse input	Multi-function digital input: same as X1 ~ X6 Pulse input: 0.1kHz ~ 50kHz Voltage range: 24V±20%
	COM	Ground terminal for +24V	Internal isolated with GND
Digital output	Y1	Open collector output	Voltage range: 24V±20%, maximum input current: 50mA
	Y2/DO	Open collector or pulse output	Open collector: same as Y1 Pulse output frequency: 0 ~ 50kHz Pulse output voltage range: 24V±20%
	COM	Open collector output common end	Internal isolated with GND
Analog input	+10V	Analog input reference voltage	10V ±3%, internal isolated with COM Maximum output current: 10mA, with short circuit and overload protection
	AI1	Analog input channel 1	0 ~ 20mA: input impedance 500Ω maximum input current: 30mA
	AI2	Analog input channel 2	0 ~ 10V: input impedance 20kΩ maximum input voltage: 15V Resolution: 12 bits (0.025%) 0 ~ 20mA or 0 ~ 10V input can be selected by jumper
	AI3	Analog input channel 3	-10V ~ 10V: input impedance 20kΩ Resolution: 12 bits (0.025%) Maximum input voltage: ±15V
	GND	Analog ground terminal	Internal isolated with COM If connects adjustable potentiometer between +10V and GND, the resistance of the potentiometer shall be more than 5kΩ
Analog output	AO1	Analog output 1	0 ~ 20mA: allowable output impedance 200 ~ 500Ω 0 ~ 10V: allowable output impedance ≥10kΩ
	AO2	Analog output 2	Output precision: 2% Resolution: 10 bits (0.1%), with short circuit protection 0 ~ 20mA or 0 ~ 10V output can be selected by jumper
	GND	Analog ground terminal	Internal isolated with COM
Relay output	RA/RB/RC	Relay output	RA-RB: normally closed RA-RC: normally open Contact capacity: 250VAC/1A, 30VDC/1A

Note:

The arrangement sequence of the control circuit terminals is as follows:

+10V	AI1	AI2	AI3	GND	AO1	AO2	GND	485+	485-	RA	RB	RC
+24V	PLC	COM	X1	X2	X3	X4	X5	X6	X7/DI	Y1	Y2/DO	COM

3.8.3 Wiring mode of the multi function digital input terminal and Y1/Y2 output terminal

- Apply internal +24V power supply, wiring in NPN sink current wiring mode

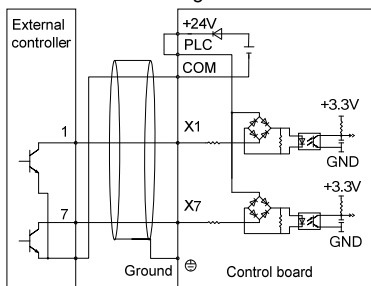

- Apply external power supply, wiring in NPN sink current wiring mode

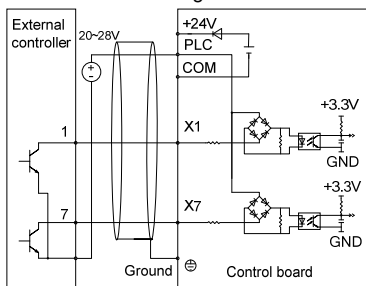

Note:

The short-link line between terminal +24V and terminal PLC must be removed.

- Apply internal +24V power supply, wiring in PNP draw-off current wiring mode

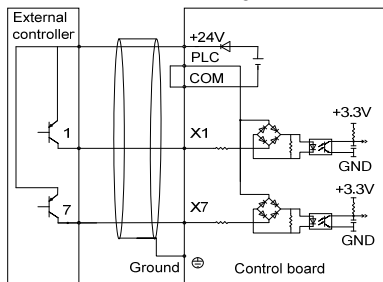

Note:

The short-link line between +24V and PLC must be removed and short circuit plate shall be connected between PLC and COM.

- Apply external power supply, wiring in PNP draw-off current wiring mode

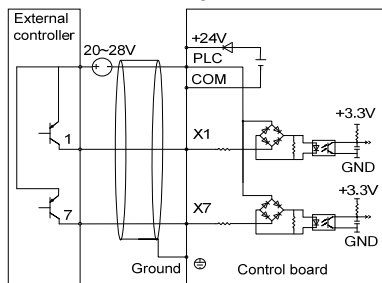

Note:

The short-link line between terminal +24V and terminal PLC must be removed.

- The wiring modes of the multi-function output terminals apply internal +24V and external power supply

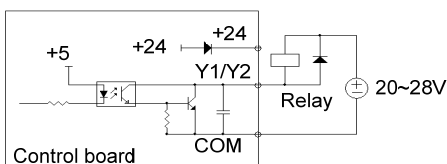
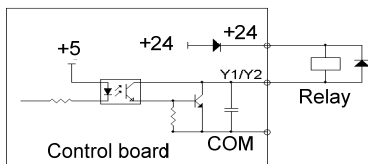

Note:

The polarity of the external diode must be checked to ensure the correctness, otherwise, Y1 and Y2 terminal will be damaged.

3.9 Schematic Diagram of Control Board

3.9.1 E5-H

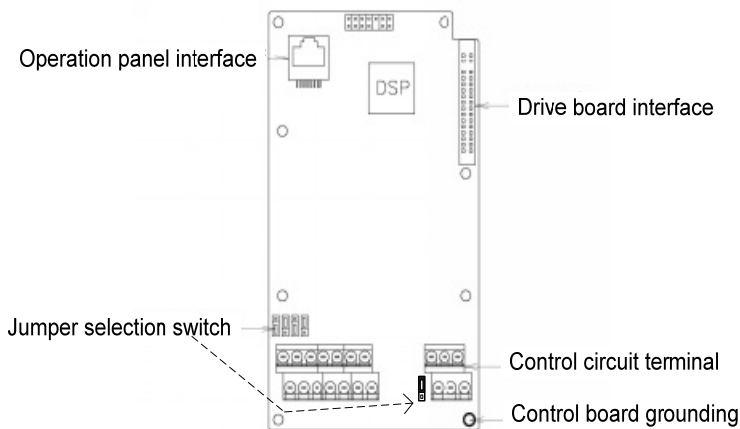

Figure3-8 Schematic diagram of control board of E5-H

3.9.2 E5-A / E5-H-34 / E5-H-63

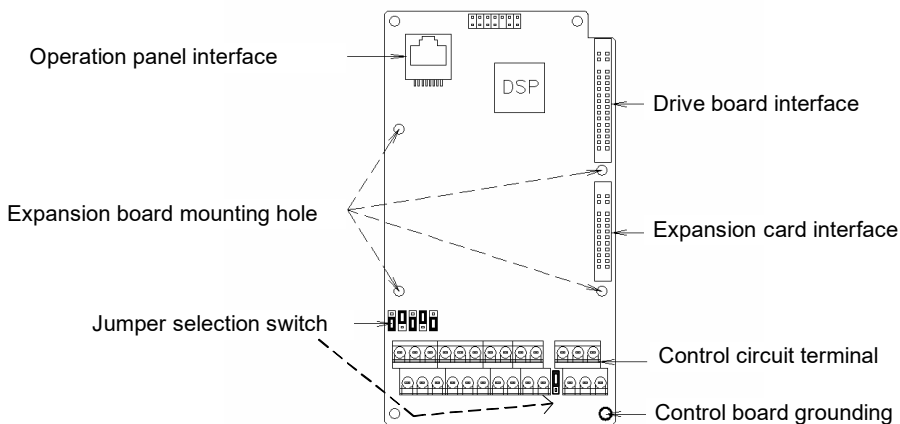

Figure3-9 Schematic diagram of control board of E5-A / E5-H-34 / E5-H-63

3.10 Control Circuit Peripheral Devices

Terminal number	Terminal screw	Tightening torque (N·m)	Wire specification (mm ²)	Wire type
+10V, AI1, AI2, AI3, 485+, 485-, AO1, AO2, GND	M3	0.5 ~ 0.6	0.75	Shielded twisted pair cable
+24V, PLC, X1, X2, X3, X4, X5, X6, X7/DI, COM, Y1, Y2/DO, COM, RA, RB, RC	M3	0.5 ~ 0.6	0.75	Shielded cable

3.11 Description of Jumper Function

Jumper selection in the following figure:



Name	Function	Default
AI1	I: AI1 analog input is current (0 ~ 20mA) V: AI1 analog input is voltage (0 ~ 10V)	0 ~ 10V
AI2	I: AI2 analog input is current (0 ~ 20mA) V: AI2 analog input is voltage (0 ~ 10V)	0 ~ 20mA
AO1	I: AO1 analog output is current (0 ~ 20mA) V: AO1 analog output is voltage (0 ~ 10V)	0 ~ 10V
AO2	I: AO2 analog output is current (0 ~ 20mA) V: AO2 analog output is voltage (0 ~ 10V)	0 ~ 20mA
485	485 terminal resistor selection: ON: 100Ω terminal resistor is selected OFF: Terminal resistor is not selected	Not selected
S6	Control board grounded selection: ON: Control board is grounded OFF: Control board is non-grounded	Grounded

Chapter 4 Operation Panel

4.1 Introduction to Operation Panel



Shuttle type operation panel (V6-DP01)



















Key-type operation panel (V6-DP02)

Figure 4-1 Operation panel

4.2 Descriptions of Indicators

Symbol of Indicator		Name	Descriptions	Color
Unit indicator	Hz	Frequency indicator	On: Current displayed value unit is running frequency Flash: Current displayed value unit is setting frequency	Green
	A	Current indicator	On: Current displayed value unit is current	Green
	V	Voltage indicator	On: Current displayed value unit is voltage	Green
	Hz+A	Speed indicator	On: Current displayed value unit is rotating speed Flash: Current displayed value unit is setting rotating speed	Green
	Hz+V	% indicator	On: Current displayed value unit is %	Green
	A+V	Self definable indicator	On/Flash: Current displayed value unit is self-defined, see descriptions of parameter P2.04 to P2.07.	Green
	Hz+A+V	Time indicator	On: Current displayed value unit is time	Green
Status indicator	MULTI	Multi-function M key indicator	Refer to table 4-1 for using method of multi function selection keys and the meanings of MULTI indicator	Red
	MON	Run command reference mode indicator	On: Run command reference is operation panel Off: Run command reference is terminals Flash: Run command reference is communication	Red
	RUN	Running status indicator	On: Inverter is running Off: Inverter has stopped Flash: Inverter is stopping	Red
	FWD	Run forward indicator	On: In stop status, inverter had run forward command In running status, inverter is running forward Flash: Changing from forward running to reverse running	Red
	REV	Run reverse indicator	On: In stop status, inverter had run reverse command In running status, inverter is running reverse Flash: Changing from reverse running to forward running	Red

4.3 Description of Keys on Operation Panel

Symbol		Name	Function
Key type	Shuttle type		
		Programming key PRG	<ol style="list-style-type: none"> 1. Enter each level of menu 2. Confirm displayed data storage 3. Check parameters in sequence 4. Confirm changeover of the run command channel with M key
		Escape Key ESC	<ol style="list-style-type: none"> 1. Back to first level menu from second level menu; Back from first level menu to standby status, running status, and fault status from first level menu 2. Give up data storage after modifying data 3. Back to all parameters displayed mode after pressing this key for more than 5s. Refer to 4.4.3. When LCD cannot display all the parameters, use this method to re-display all the parameters 4. After pressing >> key to switch from fault display to Stop / Run parameters display, press ESC to back to fault display status
	Knob+ 	Increase Key ▲	<ol style="list-style-type: none"> 1. In first level menu, increase parameters according to edit bit 2. In second level menu, increase the parameters value 3. In stop/run status, increase the frequency reference or PID main reference
	Knob- 	Decrease Key ▼	<ol style="list-style-type: none"> 1. In first level menu, decrease parameters according to edit bit 2. In second level menu, decrease the parameters value 3. In stop/run status, decrease the frequency reference or PID main reference
		Shift Key >>	<ol style="list-style-type: none"> 1. In first level menu, press >> key to select edit bit of PX.YZ menu 2. In second level menu, press >> key to select the edit bit of data 3. In stop/run status, press >> key to display parameters such as frequency, DC BUS voltage, current and voltage, etc. 4. In fault status, change from fault display to stop/run display
		Run Key RUN	<ol style="list-style-type: none"> 1. When running command is given via operation panel, the key is used to start the motor 2. After setting the motor data identification, press RUN key to start motor data identification
		Stop/Reset Key STOP/RST	<ol style="list-style-type: none"> 1. When running command is given via operation panel, the key is used to stop the motor 2. This key is used as a stop key when inverter has fault alarm but not stop 3. When the inverter has fault and stopped, this key is used as RESET key to clear the fault alarm
		Multi-function selection Key M	See table 4-1 for the using method of multi-function selection M key function selection and the meanings of MULTI indicator
		Forward/Reverse Key FWD/REV	When running command is given via operation panel, this key is used to change the output direction of motor

Note:

- The press down the knob of shuttle type operation panel is equivalent to PRG Key.
- Pressing PRG key continuously can realize browse of all parameters.

Table 4-1 Multi-function **M** key function selection and the meanings of MULTI indicator

Value setting (P2.01)	Function	Descriptions	Meanings of MULTI indicator
0	No function	M key is defined as no function.	Normally Off: No function
1	JOG	Used as JOG operation key and is only enabled when run command is given via operation panel In stop status, press M key to enter jog operation status, and release this key to stop	On: Press M Off: Release M to finish the jog operation
2	Emergency stop 1 (stop in shortest time)	Press M key, inverter will stop in shortest time	On: Press M Off: Release M
3	Emergency stop 2 (coast to stop)	Press M key, inverter will coast to stop	On: Press M Off: Release M
4	Switchover of run command channel	Press M key to switch the run command channel: Operation panel→Terminal → Communication → Operation panel. During switchover time, there is a 5-second response time limit and the change is canceled automatically after 5-second time is exceeded. Within 5s, press PRG key to confirm the change. MON indicator indicates the run command channel	On: Press M Off: M key has been released for more than 5s or PRG key has been used to confirm the changing of the run command source
5	Switchover of parameters displayed mode FAST/bASE	Press M key to switch between FAST and bASE parameters displayed mode panel should prompt as FAST and bBASE	On: FAST, fast parameters displayed mode Off: bBASE, basic parameters displayed mode
6	Switchover of parameters displayed mode ndFt/bASE	Press M key to switch between ndFt and bBASE parameters displayed mode, the indications on the operation panel are ndFt and bBASE respectively	On: ndFt, non-factory setting parameters displayed mode Off: bBASE, basic parameters displayed mode
7	Switchover of parameters displayed mode LAST/bASE	Press M key to switch between LAST and bBASE parameters displayed mode, the indications on the operation panel are LAST and bBASE respectively	On: LAST, last change 10 parameters displayed mode Off: bBASE, basic parameters displayed mode
8	Switchover of parameters displayed mode	bBASE→FAST→ndFt→LAST→bBASE	On: non-bBASE basic parameters displayed mode Off: bBASE, basic parameters displayed mode

4.4 Menu Style

The menu style is 2-level menu.

4.4.1 Format of First Level Menu

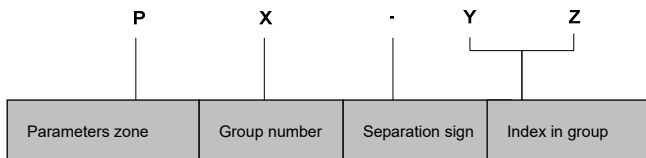

Figure 4-2 Format of first level menu

◆ Dividing the first level menu

Password action range	Parameters area	Group number in area	Parameter numbers range
Protection range of user password P0.00	User operation zone (Group P0 to Pd)	Group P0	P0.00 ~ P0.16
		Group P1	P1.00 ~ P1.08
		Group P2	P2.00 ~ P2.07
		Group P3	P3.00 ~ P3.13
		Group P4	P4.00 ~ P4.36
		Group P5	P5.00 ~ P5.13
		Group P6	P6.00 ~ P6.24
		Group P7	P7.00 ~ P7.25
		Group P8	P8.00 ~ P8.10
		Group P9	P9.00 ~ P9.18
		Group PA	PA.00 ~ PA.22
		Group Pb	Pb.00 ~ Pb.23
		Group PC	PC.00 ~ PC.06
		Group Pd	Pd.00 ~ Pd.36
	Control by manufacture 1 (Group PE)	Group PE	PE.00 ~ PE.29
	Status displayed zone (Group d0 to d2)	Group d0	d0.00 ~ d0.11
		Group d1	d1.00 ~ d1.11
		Group d2	d2.00 ~ d2.24
	Constant pressure control zone	Group H0	H0.00 ~ H0.37
	EX-DT01 extension card zone	Group H1	H1.00 ~ H1.15
A0.00 protection zone	Control by manufacture 2 (Group A0)	Group A0	A0.00 ~ A0.02
C0.00 protection zone	Reserved (Group C0)	Reserved	Reserved
U0.00 protection zone	Reserved (Group U0)	Reserved	Reserved
U1.00 protection zone	Reserved (Group U1 to U3)	Reserved	Reserved

◆ Structure of first level menu

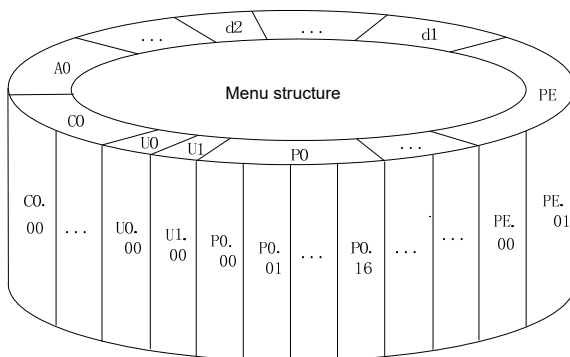

Figure 4-3 Structure of first level menu

4.4.2 Format of Second Level Menu

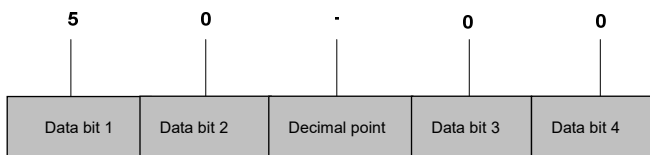

Figure 4-4 Format of second level menu

◆ Format of display/set for second level menu

Display/set decimal

From data bit 1 to 4, the characters of 0, 1.....9 can be displayed or set.

When displayed data >9999, the last bit will be omitted:

For example:

When data is 12345, operation panel displays "1234."

When data is 1234.5, operation panel displays "1234"

When data is 123.45, operation panel displays "123.4"

When data is 12.345, operation panel displays "12.34"

Display/set hex code:

From data bit 1 to 4, the characters of 0, 1.....9, A, B, C, D, E and F can be displayed or set.

◆ Meanings of 0.0.0.0. displayed in second level menu

After entering second level menu, besides the displayed data, there are also 4 dots, this means the password protection and you need to enter the password. The parameters that needs password input are P0.00, PE.00, A0.00, C0.00, U0.00 and U1.00. Group PE, C0, U0 and U1 are factory reserved.

4.4.3 Menu Mode

Value setting (P0.02)	Menu mode name	Visible parameters	Operation panel display
0	Basic menu mode	See the table 5.1 for all parameters	bASE
1	Fast menu mode	Quickly display the menu parameters in common use	FASt
2	Non-factory setting menu mode	Only display the parameters different from factory settings	ndFt
3	Last changed 10 parameters menu mode	Display the last changed 10 parameters and P0.02	LAST

◆ Basic menu mode bASE

Basic menu includes all the parameters mentioned in this user's manual. Except for the special descriptions, all the descriptions of this manual are in this menu mode.

◆ Fast menu mode FASt

Fast menu includes some common parameters and you can start the inverter by setting only a few parameters so as to realize the fast application.

◆ Non-factory setting menu mode ndFt

This menu mode is used to search for the parameters different from the factory settings for the convenience of understanding the parameter setting.

◆ Last changed 10 parameters menu mode LAST

This menu mode is used to display the last changed 10 parameters and P0.02. If the password protection is set, only P0.00 and C0.00 can be viewed. The last changed 10 parameters, P0.00 and P0.02 can be viewed only when correct password is entered into P0.00.

◆ Method of back to basic menu

1. By setting parameter P0.02 to 0, then the menu returns to basic menu mode after bASE is displayed.
2. By using **M** key: Define the function of multi-function key **M** as menu switchover function, and then press this key to switch the menu mode. Refer to table 4-1 for the methods of using multi-function key and meanings of MULTI indicator.
3. By pressing **ESC** for a long time: Press **ESC** and do not release it for more than 5s, then the menu returns to basic menu mode after bASE is displayed. If bASE is not displayed, this means the menu is already in basic menu mode.

4.4.4 Common Characters Displayed by LED







































Except the parameters in first and second level menus, the operation panel will also display the following characters as shown in the following table:

Prompt symbol	Meaning	Prompt symbol	Meaning
8.8.8.8.	Instantaneous display of inverter when inverter is powered on	LoAd	The parameters are being copied and this symbol will be displayed.
-LU-	Inverter DC BUS voltage too low	Loc1	Operation panel is locked
-dc-	Inverter is in DC braking status	Loc2	Except M key, other keys are locked
-At-	Inverter is in motor data identification	Loc3	Except RUN and STOP/RST keys, other keys are locked
bASE	Basic menu (P0.02=0)	ndFt	Non factory setting parameters displayed
CoPy	The parameters are being downloaded and this symbol will be displayed	P.Clr	Password is cleared, see 4.5 for password operation
dEFt	Restore to factory settings (P0.01=2 to 5)	P.SET	Password is set successfully
E.XXX	Fault is displayed. Refer to chapter 7	Prot	Password protection is enabled
FASt	Fast menu (P0.02=1)	SLId	Operation panel is identified as shuttle type
HoLd	The parameter copy or upload function of operation panel is disabled	ULoc	Press ESC+>>+v together to unlock the panel
LASt	Last changed 10 parameters displayed	UpDn	Operation panel is identified as key type.
LinE	Communication of operation panel fails		

If the symbol is not listed in the table, please contact the local distributor or manufacture.

4.4.5 Identify Symbols Displayed Via LED

The relationship between characters displayed by LED and characters/numbers are as follows:

LED	Meanings of characters	LED display	Meanings of characters	LED display	Meanings of characters	LED display	Meanings of characters
	0		A		I		S
	1		b		J		T
	2		C		L		t
	3		c		N		U
	4		d		n		V
	5		E		O		y
	6		F		o		-
	7		G		P		8.
	8		H		q		.
	9		h		r		

4.5 Password Operation

■ Set Password

Enter password parameter P0.00 and set to the identical parameters for two times continuously. After "P.Set" is displayed, the password setting is successful. See 4.8.3 for password setting.

■ Password Verification

Enter password parameter P0.00 and enter password correctly and you can see the parameters protected by password. See 4.8.4 descriptions of password verification.

■ Clear Password

After passing password verification, enter password parameter P0.00 and set to 0000 continuously for two times, after "P. CLR" is displayed, this means the password is successfully cleared. Then you can access the password protection area without password verification. See 4.8.5 descriptions of clearing password.

■ Method of Enabling Password

There are three methods can be used to activate the password protection:

1. Press **ESC+PRG** +**▲** simultaneously (for shuttle type, turning clock wise is equivalent to the **▲** key) to display "Prot". If key locking function is active, "Loc1" (P2.00=1) or "Loc2"(P2.00=2) or "Loc3"(P2.00=3) is displayed.
2. Do not press any key for continuous 5 minutes.
3. Power off till the inverter without display and power on again.

4.6 Lock and Unlock Keys

■ Lock Keys

- ◆ Set the function of locking keys. Select the P2.00 key locking functions:

0: Do not lock the keys on the operation panel and all the keys can be used

1: Lock the keys on the operation panel and all the keys cannot be used

2: Except multi-function key **M**, all the keys cannot be used

3: Except **RUN** and **STOP/RST** keys, all the keys cannot be used

- ◆ Activate key locking function. One of following three modes can be selected to activate key locking function:

1. Press **ESC+PRG** +**▲** simultaneously (for shuttle type, turning clock wise is equivalent to the **▲** key) to display "Loc1" (P2.00=1) or "Loc2"(P2.00=2) or "Loc3"(P2.00=3), the operation panel is locked according to the setting method of P2.00. When P2.00=0, "Prot" is displayed and the operation panel is not locked and only the password protection is enabled.

2. Power on the inverter again to lock the operation panel.

3. If there is no key operation within 5 minutes after setting key locking function, the operation panel is locked automatically.

■ Unlock Keys:

Press **ESC+>>+▼** keys simultaneously (for shuttle type, turning anti-clock wise is equivalent to **▼** key) to unlock.

4.7 Operation Panel Display and Key Operation

4.7.1 Classification of Display Status

There are 8 types of display status of operation panel:

SN	Status	Meaning
1	Display parameters in stop status	Press >> key to switch the displayed parameters P2.03 can be used to set the displayed parameters
2	Display parameters in running status	Press >> key to switch the displayed parameters P2.02 can be used to set the displayed parameters
3	Fault and alarm display status	In other 7 kinds of display status, if there is any fault happens, directly enter this status
4	Display status of first level menu	When the keys are not locked, in status of SN1, SN2, SN3 and SN7, press PRG to enter
5	Display status of second level menu	In the display status of first level menu, press PRG to enter
6	Password verification status	If password protection is enabled, press PRG to enter in the display status of first level menu
7	Password modification status	In the display status of stop and running parameters, press ▲ and ▼ to enter
8	Information prompt status	See 4.4.5 for identifying the LED display characters

4.7.2 Display Status and Operation Process

◆ **>>** key

In the display status of first level menu, press **>>** key to select the edit bit of parameter PX.YZ.

In second level menu or password verification status, press **>>** key to select the data edit bit.

◆ Display status auto changed

If no key is pressed for 30s, the screen automatically returns to the display status of parameter in stop status or running status.

If no key is pressed for 1 minute, clear menu edit status of PX.YZ to return to P0.00.

If there is password setting or key locking setting, and if no key is pressed for 5 minutes, the password protection or locking status will be activated automatically.

◆ Display status and operation procedure

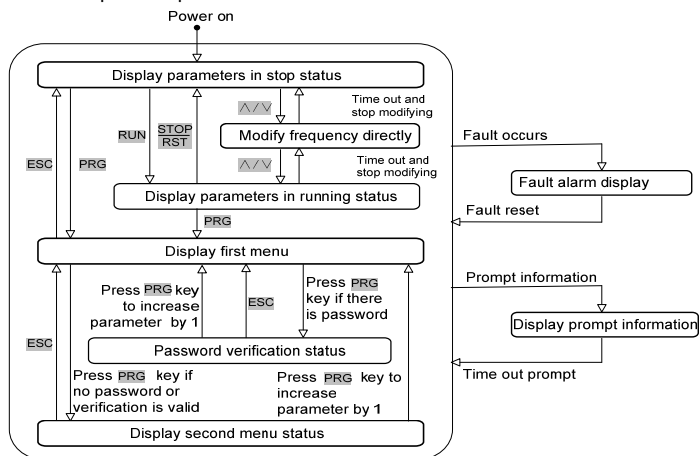

Figure 4-5 Display status and operation procedure

4.8 Operation Example

In the following example, the displayed parameters in stop status is reference frequency, the factory setting is 50.00Hz. The underscored line in the figure means the bit that is being edited.

4.8.1 Restore to Factory Setting

For example, setting P0.01=5: Restore all the parameters in zone P to factory settings.



4.8.2 Setting Frequency

For example, setting P0.05=25.00Hz.

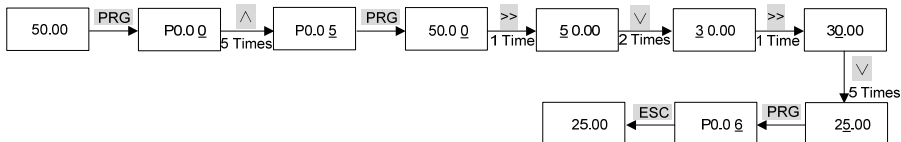

4.8.3 Setting Password

For example, setting user password P0.00 to 0003.



4.8.4 Password Verification

Assume that the parameters are protected by password and the password is 3. If the password protection is not enabled, you can press ESC+PRG+^ to enable the password in last example of P0.00. You can perform the password verification according to the following process:

Note:

If you use RS 485 communication mode to perform password verification, please refer to the appendix A.



4.8.5 Clear Password

For example, clear the user password P0.00.

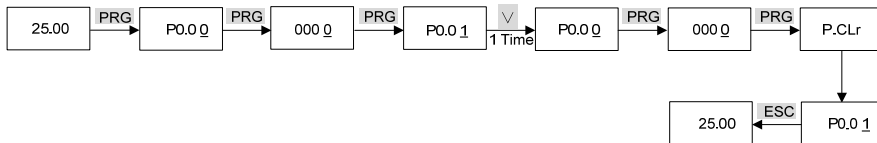

4.9 Running for the First Time

Please follow the procedures to run for the first time:

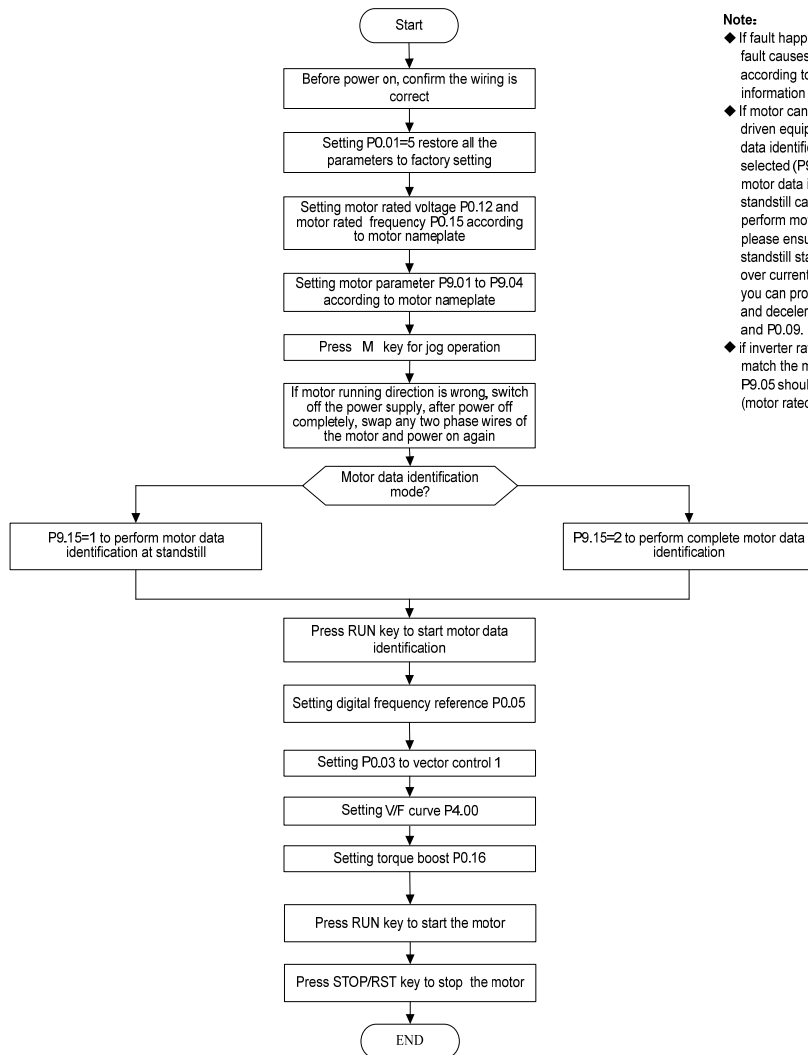

Note:

- ◆ If fault happens, please judge the fault causes and clear the fault according to 7.1 Fault and alarm information list.
- ◆ If motor can be de-coupled from the driven equipment, complete motor data identification should be selected (P9.15=2), otherwise only motor data identification at standstill can be selected. Before perform motor data identification please ensure the motor is in standstill status. If over voltage or over current happens in process, you can prolong the acceleration and deceleration times of P0.08 and P0.09.
- ◆ If inverter rated power does not match the motor rated power, P9.05 should be set 40% of P9.04 (motor rated current)

Chapter 5 Parameter List

Meanings of Each Item in Parameter Table

Item	Meanings
No.	The number of parameter, such as P0.00
Name	The name of parameter, which explains the parameter's meanings
Default	The value of factory setting (see P0.01)
Range	The value from minimum value to maximum value that can be set to this parameter
Unit	V: Voltage; A: Current; %:Percentage; Hz, kHz: Frequency; ms, s, min, h: Time; °C: Celsius degree; Ω: Ohm; rpm: Revolutions per minute; mH: Milli-henry; bps: Baud rate; kW: Power; /: No unit
Property	○: This parameter can be changed during operation ×: This parameter can only be changed during stopping status *: This parameter is read-only
Description	Parameter setting list and descriptions
User	Used for recording parameters by user

Note:

- E5 series built-in multiple control mode for fan and pump to realize customized energy saving requirement. For details, refer to the parameter descriptions of Pb.21 and Pb.22.
- E5 series built-in constant pressure control and sleep function. For details, refer to the parameter descriptions of group H0.

5.1 Complete Parameter List

No.	Name	Default	Range	Unit	Property	Description	User
Group P0 Basic Function Parameters							
P0.00	User password	0000	0000 ~ FFFF	/	○	0000: No password Other: Password protection	
P0.01	Parameters protection	0	0 ~ 5	/	×	0: All the parameters can be modified 1: All the parameters cannot be modified 2: Restore parameter values in zone P to factory setting 3: Restore parameter values in zone P to factory setting except group P9 4: Restore parameter values in zone P and zone A to factory setting 5: Restore all the parameters to factory setting except group d	
P0.02	Parameters display mode	0	0 ~ 3	/	○	0: Basic menu mode 1: Fast menu mode 2: Non-factory setting menu mode 3: Last changed 10 parameters menu mode	
P0.03	Control mode	0	0 ~ 3	/	×	0: Process open loop control 1: Analog feedback process close loop control 2: Single phase pulse feedback process close loop control 3: Composite control	
P0.04	Open loop main reference channel	0	0 ~ 4	/	○	0: Open loop digital frequency reference(P0.05) 1: AI1 analog reference 2: AI2 analog reference 3: AI3 analog reference 4: DI pulse reference	
P0.05	Open loop digital frequency reference	50.00	0.00 ~ 300.00	Hz	○	P0.13 ~ P0.14	

No.	Name	Default	Range	Unit	Property	Description	User
P0.06	Run command channel selection	0	0 ~ 2	/	○	0: Operation panel 1: Terminal 2: Communication	
P0.07	Running direction command	0	0 ~ 1	/	○	0: Run forward 1: Run reverse	
P0.08	Acceleration time 0	6.0	0.1 ~ 3600.0	s	○	15kW and below 6.0s by default 18.5kW and above 20.0s by default	
P0.09	Deceleration time 0	20.0					
P0.10	S-curve time	0.0	0.0 ~ 60.0	s	○	0.0 ~ 3600.0s	
P0.11	Max. output frequency	50.00	0.01 ~ 300.00	Hz	×	P0.13 ~ 300.00Hz	
P0.12	Max. output voltage	380	1 ~ 480	V	×	Motor rated voltage	
P0.13	Frequency upper limit	50.00	0.00 ~ 300.00	Hz	×	P0.14 ~ P0.11	
P0.14	Frequency lower limit	0.00	0.00 ~ 300.00	Hz	×	0.00Hz ~ P0.13	
P0.15	Basic operating frequency	50.00	0.00 ~ 300.00	Hz	×	Motor rated frequency	
P0.16	Torque boost	0.0	0.0 ~ 30.0	%	○	Auto torque boost: 0.0 Manual torque boost: 0.1% ~ 30.0%	
Group P1 Main and Auxiliary Reference Parameters							
P1.00	Open loop auxiliary frequency reference channel	00	00 ~ 14	/	○	Ones place: Auxiliary reference channel selection: 0: None 1: AI1 2: AI2 3: AI3 4: DI Tens place: Auxiliary reference maximum limited selection: 0: P0.11 1: Main reference	
P1.01	Open loop main frequency reference and auxiliary frequency reference calculation formula	0	0 ~ 5	/	○	0: Main + Auxiliary 1: Main - Auxiliary 2: Auxiliary-50% 3: Main + Auxiliary-50% 4: Take max. value 5: Take min. value	
P1.02	Analog feedback close loop control main reference channel	0	0 ~ 4	/	○	0: P8.00 1: AI1 2: AI2 3: AI3 4: DI	
P1.03	Analog feedback close loop control auxiliary reference channel	0	0 ~ 4	/	○	0: None 1: AI1 2: AI2 3: AI3 4: DI	
P1.04	Analog feedback close loop control main reference and auxiliary reference calculation formula	0	0 ~ 5	/	○	0: Main + Auxiliary 1: Main - Auxiliary 2: Auxiliary-50% 3: Main + Auxiliary-50% 4: Take max. value 5: Take min. value	
P1.05	Analog feedback close loop control main feedback channel	1	1 ~ 4	/	○	1: AI1 2: AI2 3: AI3 4: DI	
P1.06	Analog feedback close loop control auxiliary feedback channel	0	0 ~ 4	/	○	0: None 1: AI1 2: AI2 3: AI3 4: DI	
P1.07	Analog feedback close loop control main feedback and auxiliary feedback calculation formula	0	0 ~ 5	/	○	0: Main + Auxiliary 1: Main - Auxiliary 2: Auxiliary-50% 3: Main + Auxiliary-50% 4: Take max. value 5: Take min. value	
P1.08	Process open loop and close loop calculation formula for composite control	0	0 ~ 1	/	○	0: Frequency reference + PID 1: Frequency reference - PID	

No.	Name	Default	Range	Unit	Property	Description	User
Group P2 Key and Display Parameters							
P2.00	Operation panel key-locking function selection	0	0 ~ 3	/	○	0: No locking 1: Locking all keys 2: Locking all keys except MULTI key 3: Locking all keys except RUN and STOP/RST keys	
P2.01	Multi-function M key function selection	1	0 ~ 8	/	○	0: No function 1: Jog function 2: Emergency stop 1 (stop in shortest time) 3: Emergency stop 2 (coast to stop) 4: Switchover of run command channel 5: Switchover of parameter display mode (fast/all) 6: Switchover of parameter display mode (non-factory setting/all) 7: Switchover of parameter display mode (last changed 10 parameters/all) 8: Switchover of parameter display mode (P0.02 menu mode)	
P2.02	Display parameter selection in running status	1CB0	0000 ~ FFFF	/	○	Ones place: 0: Reference frequency (Hz) 1: Bus voltage (V) 2: AI1(V) 3: AI2(V) 4: AI3(V) 5: DI (%) 6: External terminal counting 7: Motor speed (rpm) 8: Close loop reference (%) 9: Close loop feedback (%) A: Reserved (%) B: Running frequency (Hz) C: Output current (A) D: Output torque (%) E: Output power (kW) F: Output voltage (V) Tens, hundreds, thousands place: Same with above	
P2.03	Display parameter selection in stop status	3210	0000 ~ FFFF	/	○	Ones place: 0: Reference frequency (Hz) 1: Bus voltage (V) 2: AI1(V) 3: AI2(V) 4: AI3(V) 5: DI (%) 6: External terminal counting 7: Motor rotation speed (rpm) 8: Close loop reference (%) 9: Close loop feedback (%) A ~ F: Reserved Tens, hundreds, thousands place: Same with above	
P2.04	Display parameter benchmark in running status	0	0 ~ F	/	○	0 ~ F	
P2.05	Display parameter coefficient in running status	0.0	0.0 ~ 1000.0	%	○	0 ~ 1000.0%	
P2.06	Display parameter benchmark in stop status	0	0 ~ F	/	○	0 ~ F	
P2.07	Display parameter coefficient in stop status	0.0	0.0 ~ 1000.0	%	○	0 ~ 1000.0%	

No.	Name	Default	Range	Unit	Property	Description	User
Group P3 Start/stop Parameters							
P3.00	Start mode	0	0 ~ 2	/	×	0: Normal start 1: Start after DC injection 2: Flying start	
P3.01	DC injection current	0.0	0.0 ~ 120.0	%	×	E5-H: 0.0 ~ 120.0% of inverter rated current E5-A: 0.0 ~ 90.0% of inverter rated current	
P3.02	DC injection active time	0.0	0.0 ~ 30.0	s	×	0.00 ~ 30.0s	
P3.03	Start frequency	0.50	0.00 ~ 60.00	Hz	×	Range: 0.00 ~ the lower of P0.13 and 60.00Hz	
P3.04	Start frequency holding time	0.0	0.0 ~ 3600.0	s	×	0.0 ~ 3600.0s	
P3.05	Stop mode	0	0 ~ 2	/	×	0: Deceleration to stop 1: Coast to stop 2: Deceleration to stop+DC braking	
P3.06	DC braking start frequency	0.00	0.00 ~ 300.00	Hz	×	0.00 ~ 300.00Hz	
P3.07	DC braking current	0.0	0.0 ~ 120.0	%	×	E5-H: 0.0 ~ 120.0% of inverter rated current E5-A: 0.0 ~ 90.0% of inverter rated current	
P3.08	DC braking active time	0.0	0.0 ~ 30.0	s	×	0.0 ~ 30.0s	
P3.09	RUN reverse selection	0	0 ~ 1	/	×	0: Run reverse is allowed 1: Run reverse is not allowed	
P3.10	Forward / reverse switchover dead zone time	0.0	0.0 ~ 3600.0	s	×	0.0 ~ 3600.0s	
P3.11	Jog frequency	5.00	0.10 ~ 50.00	Hz	×	0.10 ~ 50.00Hz	
P3.12	Jog acceleration time	20.0	0.1 ~ 60.0	s	×	0.1 ~ 60.0s	
P3.13	Jog deceleration time	20.0	0.1 ~ 60.0	s	×	0.1 ~ 60.0s	
Group P4 Multi-step Parameters							
P4.00	V/F curve selection	0	0 ~ 6	/	×	0: Linear V/F 1: Multi-point V/F (P4.01 ~ P4.08) 2: Power of 1.2 V/F 3: Power of 1.4 V/F 4: Power of 1.6 V/F 5: Power of 1.8 V/F 6: Power of 2 V/F	
P4.01	Multi-point V/F frequency F0	1.00	0.00 ~ 300.00	Hz	×	F0<F1	
P4.02	Multi-point V/F voltage V0	3.0	0.0 ~ 100.0	%	×	0.0 ~ 100.0%	
P4.03	Multi-point V/F frequency F1	10.00	0.00 ~ 300.00	Hz	×	F1<F2	
P4.04	Multi-point V/F voltage V1	20.0	0.0 ~ 100.0	%	×	0.0 ~ 100.0%	
P4.05	Multi-point V/F frequency F2	25.00	0.00 ~ 300.00	Hz	×	F2<F3	
P4.06	Multi-point V/F voltage V2	50.0	0.0 ~ 100.0	%	×	0.0 ~ 100.0%	
P4.07	Multi-point V/F frequency F3	50.00	0.00 ~ 300.00	Hz	×	F3≤Motor rated frequency P0.15	
P4.08	Multi-point V/F voltage V3	100.0	0.0 ~ 100.0	%	×	0.0 ~ 100.0%	
P4.09	Acceleration time 1	20.0	0.1 ~ 3600.0	s	×	0.1 ~ 3600.0s	
P4.10	Deceleration time 1	20.0	0.1 ~ 3600.0	s	×	0.1 ~ 3600.0s	
P4.11	Acceleration time 2	20.0	0.1 ~ 3600.0	s	×	0.1 ~ 3600.0s	
P4.12	Deceleration time 2	20.0	0.1 ~ 3600.0	s	×	0.1 ~ 3600.0s	
P4.13	Acceleration time 3	20.0	0.1 ~ 3600.0	s	×	0.1 ~ 3600.0s	
P4.14	Deceleration time 3	20.0	0.1 ~ 3600.0	s	×	0.1 ~ 3600.0s	

No.	Name	Default	Range	Unit	Property	Description	User
P4.15	Multi-step digital voltage reference 1	1.00	0.00 ~ 10.00	V	○	0.00 ~ 10.00V	
P4.16	Multi-step digital voltage reference 2	2.00	0.00 ~ 10.00	V	○	0.00 ~ 10.00V	
P4.17	Multi-step digital voltage reference 3	3.00	0.00 ~ 10.00	V	○	0.00 ~ 10.00V	
P4.18	Multi-step digital voltage reference 4	5.00	0.00 ~ 10.00	V	○	0.00 ~ 10.00V	
P4.19	Multi-step digital voltage reference 5	6.00	0.00 ~ 10.00	V	○	0.00 ~ 10.00V	
P4.20	Multi-step digital voltage reference 6	8.00	0.00 ~ 10.00	V	○	0.00 ~ 10.00V	
P4.21	Multi-step digital voltage reference 7	10.00	0.00 ~ 10.00	V	○	0.00 ~ 10.00V	
P4.22	Multi-step frequency reference 1	5.00	0.00 ~ 300.00	Hz	○	P0.13 ~ P0.14	
P4.23	Multi-step frequency reference 2	8.00	0.00 ~ 300.00	Hz	○	P0.13 ~ P0.14	
P4.24	Multi-step frequency reference 3	10.00	0.00 ~ 300.00	Hz	○	P0.13 ~ P0.14	
P4.25	Multi-step frequency reference 4	15.00	0.00 ~ 300.00	Hz	○	P0.13 ~ P0.14	
P4.26	Multi-step frequency reference 5	18.00	0.00 ~ 300.00	Hz	○	P0.13 ~ P0.14	
P4.27	Multi-step frequency reference 6	20.00	0.00 ~ 300.00	Hz	○	P0.13 ~ P0.14	
P4.28	Multi-step frequency reference 7	25.00	0.00 ~ 300.00	Hz	○	P0.13 ~ P0.14	
P4.29	Multi-step frequency reference 8	28.00	0.00 ~ 300.00	Hz	○	P0.13 ~ P0.14	
P4.30	Multi-step frequency reference 9	30.00	0.00 ~ 300.00	Hz	○	P0.13 ~ P0.14	
P4.31	Multi-step frequency reference 10	35.00	0.00 ~ 300.00	Hz	○	P0.13 ~ P0.14	
P4.32	Multi-step frequency reference 11	38.00	0.00 ~ 300.00	Hz	○	P0.13 ~ P0.14	
P4.33	Multi-step frequency reference 12	40.00	0.00 ~ 300.00	Hz	○	P0.13 ~ P0.14	
P4.34	Multi-step frequency reference 13	45.00	0.00 ~ 300.00	Hz	○	P0.13 ~ P0.14	
P4.35	Multi-step frequency reference 14	48.00	0.00 ~ 300.00	Hz	○	P0.13 ~ P0.14	
P4.36	Multi-step frequency reference 15	50.00	0.00 ~ 300.00	Hz	○	P0.13 ~ P0.14	
Group P5 Multi-function Input Parameters							
P5.00	Digital input terminal X1 function selection	02	00 ~ 99	/	×	Refer to descriptions of multi function input parameters in group P5 in Chapter 6	
P5.01	Digital input terminal X2 function selection	03	00 ~ 99	/	×		
P5.02	Digital input terminal X3 function selection	99	00 ~ 99	/	×		
P5.03	Digital input terminal X4 function selection	99	00 ~ 99	/	×		
P5.04	Digital input terminal X5 function selection	99	00 ~ 99	/	×		
P5.05	Digital input terminal X6 function selection	99	00 ~ 99	/	×		
P5.06	Digital input terminal X7/DI function selection	99	00 ~ 99	/	×		

No.	Name	Default	Range	Unit	Property	Description	User
P5.07	X1 to X7 terminal filter time	0.100	0.000 ~ 1.000	s	×	0.000 ~ 1.000s	
P5.08	X1 terminal delay time	0.0	0.0 ~ 999.9	s	×		
P5.09	X2 terminal delay time	0.0	0.0 ~ 999.9	s	×		
P5.10	Maximum input pulse frequency	10.0	0.1 ~ 50.0	kHz	×	0.1 ~ 50.0kHz	
P5.11	Start/stop mode selection	0	0 ~ 3	/	×	0: 2-wire control 1 1: 2-wire control 2 2: 3-wire control 1 3: 3-wire control 2	
P5.12	Preset counting value setting	0	0 ~ 9999	/	×	0 ~ 9999	
P5.13	Designated counting value setting	0	0 ~ 9999	/	×	0 ~ 9999	
Group P6 Analog Reference Parameters							
P6.00	AI1 to AI3 and DI input curve selection	4444	0000 ~ 4444	/	○	0: Curve 1(2 points, P6.01 to P6.04) 1: Curve 2(2 points, P6.05 to P6.08) 2: Curve 3(2 points, P6.09 to P6.12) 3: Curve 4(4 points, P6.13 to P6.20) 4: None	
						Ones place: AI1 input curve selection	
						Tens place: AI2 input curve selection	
						Hundreds place: AI3 input curve selection	
						Thousands place: DI input curve selection	
P6.01	Curve 1 input point A0	0.0	0.0 ~ 110.0	%	○	0.0 ~ 110.0%	
P6.02	Reference frequency f0 corresponding to curve1 input point A0	0.00	0.00 ~ 300.00	Hz	○	0.00 ~ 300.00Hz	
P6.03	Curve 1 input point A1	100.0	0.0 ~ 110.0	%	○	0.0 ~ 110.0%	
P6.04	Reference frequency f1 corresponding to curve1 input point A1	50.00	0.00 ~ 300.00	Hz	○	0.00 ~ 300.00Hz	
P6.05	Curve2 input point A0	0.0	0.0 ~ 110.0	%	○	0.0 ~ 110.0%	
P6.06	Reference frequency f0 corresponding to curve2 input point A0	0.00	0.00 ~ 300.00	Hz	○	0.00 ~ 300.00Hz	
P6.07	Curve2 input point A1	100.0	0.0 ~ 110.0	%	○	0.0 ~ 110.0%	
P6.08	Reference frequency f1 corresponding to curve2 input point A1	50.00	0.00 ~ 300.00	Hz	○	0.00 ~ 300.00Hz	
P6.09	Curve3 input point A0	0.0	0.0 ~ 110.0	%	○	0.0 ~ 110.0%	
P6.10	Per unit value B0 corresponding to curve3 input point A0	0.0	0.0 ~ 110.0	%	○	0.0 ~ 110.0%	
P6.11	Curve3 input point A1	100.0	0.0 ~ 110.0	%	○	0.0 ~ 110.0%	
P6.12	Per unit value B1 corresponding to curve3 input point A1	100.0	0.0 ~ 110.0	%	○	0.0 ~ 110.0%	
P6.13	Curve4 input point A0	0.0	0.0 ~ 110.0	%	○	0.0 ~ 110.0%	
P6.14	Per unit value B0 corresponding to curve4 input point A0	0.0	0.0 ~ 110.0	%	○	0.0 ~ 110.0%	

No.	Name	Default	Range	Unit	Property	Description	User
P6.15	Curve4 input point A1	25.0	0.0 ~ 110.0	%	○	0.0 ~ 110.0%	
P6.16	Per unit value B1 corresponding to curve4 input point A1	25.0	0.0 ~ 110.0	%	○	0.0 ~ 110.0%	
P6.17	Curve4 input point A2	50.0	0.0 ~ 110.0	%	○	0.0 ~ 110.0%	
P6.18	Per unit value B2 corresponding to curve4 input point A2	50.0	0.0 ~ 110.0	%	○	0.0 ~ 110.0%	
P6.19	Curve4 input point A3	100.0	0.0 ~ 110.0	%	○	0.0 ~ 110.0%	
P6.20	Per unit value B3 corresponding to curve4 input point A3	100.0	0.0 ~ 110.0	%	○	0.0 ~ 110.0%	
P6.21	AI1 ~ AI3, DI analog channel function selection	0000	0000 ~ 6666	/	×	0: Open loop frequency reference Close loop analog reference Close loop analog feedback 1~4: Reserved 5: Motor temperature feedback 6: Reserved	
						Ones place: AI1 function selection	
						Tens place: AI2 function selection	
						Hundreds place: AI3 function selection	
	Thousands place: DI function selection						
P6.22	AI1 filter time	0.004	0.000 ~ 1.000	s	×	0.000 ~ 1.000s	
P6.23	AI2 filter time	0.004	0.000 ~ 1.000	s	×	0.000 ~ 1.000s	
P6.24	AI3 filter time	0.004	0.000 ~ 1.000	s	×	0.000 ~ 1.000s	
P6.25	AI1 configured as multi-function digital input terminal	99	00 ~ 99	/	×	99: Configured as analog input 00 ~ 98: Configured as digital input, refer to P5.00 to P5.06	
P6.26	AI2 configured as multi-function digital input terminal	99	00 ~ 99	/	×	99: Configured as analog input 00 ~ 98: Configured as digital input, refer to P5.00 to P5.06	
P6.27	AI3 configured as multi-function digital input terminal	99	00 ~ 99	/	×	99: Configured as analog input 00 ~ 98: Configured as digital input, refer to P5.00 to P5.06	
Group P7 Multi-function Output Parameters							
P7.00	Y1 output function selection	0	0 ~ 47	/	○	Refer to descriptions of multi function output parameters in group P7 in Chapter 6	
P7.01	Y2/DO output function selection	1	0 ~ 71	/	○		
P7.02	Relay output function selection	14	0 ~ 47	/	○		
P7.03	AO1 output function selection	48	48 ~ 71	/	○		
P7.04	AO2 output function selection	49	48 ~ 71	/	○		
P7.05	AO1 gain	100.0	0.0 ~ 200.0	%	○	0.0 ~ 200.0%	
P7.06	AO1 bias	0.0	0.0 ~ 200.0	%	○	0.0 ~ 200.0%	
P7.07	AO2 gain	100.0	0.0 ~ 200.0	%	○	0.0 ~ 200.0%	
P7.08	AO2 bias	0.0	0.0 ~ 200.0	%	○	0.0 ~ 200.0%	

No.	Name	Default	Range	Unit	Property	Description	User
P7.09	Positive logic or negative logic selection for gain and bias	0000	0 ~ 1111	/	○	Ones place: AO1 gain: 0: Positive 1: Negative Tens place: AO1 bias: 0: Positive 1: Negative Hundreds place: AO2 gain: 0: Positive 1: Negative Thousands place: AO2 bias: 0: Positive 1: Negative	
P7.10	Y2/DO maximum output pulse frequency	10.0	0.1 ~ 50.0	kHz	○	0.1 ~ 50.0kHz	
P7.11	Output signal type selection (Y1 / relay)	000	000 ~ 101	/	×	Ones place: Y1 output signal type 0: Level 1: Pulse Tens place: Reserved Hundreds place: Relay output signal type 0: Level 1: Pulse	
P7.12	Y1 output function action delay time	0.0	0.0 ~ 999.9	s	○		
P7.13	Y1 output pulse width	0.0	0.0 ~ 999.9	s	○		
P7.14	Y2 output function action delay time	0.0	0.0 ~ 999.9	s	○		
P7.15	Reserved	0.0	0.0 ~ 999.9	s	○		
P7.16	Relay output function action delay time	0.0	0.0 ~ 999.9	s	○		
P7.17	Relay output pulse width	0.0	0.0 ~ 999.9	s	○		
P7.18	Zero current detection level	0.0	0.0 ~ 50.0	%	○	0.0 ~ 50.0%	
P7.19	Running frequency arrival detection level	2.50	0.00 ~ 300.00	Hz	○	0.00 ~ 300.00Hz	
P7.20	FDT1 level upper limit	50.00	0.00 ~ 300.00	Hz	○	0.00 ~ 300.00Hz	
P7.21	FDT1 level lower limit	49.00	0.00 ~ 300.00	Hz	○	0.00 ~ 300.00Hz	
P7.22	FDT2 level upper limit	25.00	0.00 ~ 300.00	Hz	○	0.00 ~ 300.00Hz	
P7.23	FDT2 level lower limit	24.00	0.00 ~ 300.00	Hz	○	0.00 ~ 300.00Hz	
P7.24	Virtual terminal selection	000	000 ~ 101	/	○	Ones place: Multi function input terminal Xi: 0: Real terminal is enabled 1: Virtual terminal is enabled Tens place: Reserved Hundreds place: Y1/Y2/Relay terminal: 0: Real terminal is enabled 1: Virtual terminal is enabled	
P7.25	Input and output terminal active state selection	0000	000 ~ 1131	/	○	Ones place: Multi function input terminal Xi: 0: Xi is active if current flowing through Xi 1: Xi is active if no current flowing through Xi Tens place: Multi function output terminal Yi: 0: Y1 is active if current flowing through Y1 Y2 is active if current flowing through Y2 1: Y1 is active if no current flowing through Y1 Y2 is active if current flowing through Y2 2: Y1 is active if current flowing through Y1 Y2 is active if no current flowing through Y2 3: Y1 is active if no current flowing through Y1 Y2 is active if no current flowing through Y2 Hundreds place: Relay terminal: 0: Relay is active if in magnetizing status 1: Relay is active if not in magnetizing status Thousands place: Reserved	

No.	Name	Default	Range	Unit	Property	Description	User
Group P8 PID Close Loop Control parameters							
P8.00	Analog feedback process close loop control digital voltage reference	0.00	0.00 ~ 10.00	V	○	Digital voltage reference for process close loop (if P0.03=1/3, P1.02=0)	
P8.01	Single phase pulse feedback process close loop control digital RPM reference	0	0 ~ 30000	rpm	○	0 ~ 30000	
P8.02	Pulse per turn for single phase pulse	1000	1 ~ 9999	/	×	1 ~ 9999	
P8.03	Proportional gain KP	0.200	0 ~ 10.000	/	○	0.000 ~ 10.000	
P8.04	Integral gain Ki	0.500	0 ~ 10.000	/	○	0.000 ~ 10.000	
P8.05	Derivative gain Kd	0.000	0 ~ 10.000	/	○	0.000 ~ 10.000	
P8.06	Sampling cycle	0.002	0.001 ~ 30.000	s	○	0.001 ~ 30.000s	
P8.07	PID deviation limit	5.0	0.0 ~ 20.0	%	○	0.0 ~ 20.0%	
P8.08	PID integral property	00	00 ~ 11	/	○	Ones place: Whether to stop integral regulation when the running frequency reaches the upper or lower limit 0: Stop integral regulation 1: Continue integral regulation Tens place: Output frequency direction: 0: Must be consistent with preset direction 1: Can regulation to reverse to preset direction	
P8.09	PID positive or negative function	0	0 ~ 1	/	○	0: Positive 1: Negative	
P8.10	PID acceleration / deceleration time	10.0	0.0 ~ 6553.5	/	○	0 ~ 6553.5	
Group P9 Motor Parameters							
P9.00	Reserved	0	0 ~ 1	/	×	Reserved	
P9.01	Motor poles	4	2 ~ 128	/	×	2 ~ 128	
P9.02	Motor rated speed	1500	0 ~ 30000	rpm	×	0 ~ 30000rpm	
P9.03	Motor rated power	Factory	0.4 ~ 6553.5	kW	×	0.4 ~ 999.9kW	
P9.04	Motor rated current	Factory	0.1 ~ 6553.5	A	×	0.1 ~ 999.9A	
P9.05	No-load current I0	Factory	0.1 ~ 6553.5	A	×	0.1 ~ 999.9A	
P9.06	Stator resistance R1	Factory	0 ~ 65.000	Ω	×	0.000 ~ 65.000Ω	
P9.07	Stator leakage inductance L1	Factory	0 ~ 2000.0	mH	×	0.0 ~ 2000.0mH	
P9.08	Rotor resistance R2	Factory	0 ~ 65.000	Ω	×	0.000 ~ 65.000Ω	
P9.09	Mutual inductance L2	Factory	0.0 ~ 2000.0	mH	×	0.0 ~ 2000.0mH	
P9.10	Magnetic flux saturation coefficient 1	87.00	0 ~ 100.00	%	×	0.0 ~ 100.00%	
P9.11	Magnetic flux saturation coefficient 2	80.00	0 ~ 100.00	%	×	0.0 ~ 100.00%	
P9.12	Magnetic flux saturation coefficient 3	75.00	0 ~ 100.00	%	×	0.0 ~ 100.00%	
P9.13	Magnetic flux saturation coefficient 4	72.00	0 ~ 100.00	%	×	0.0 ~ 100.00%	
P9.14	Magnetic flux saturation coefficient 5	70.00	0 ~ 100.00	%	×	0.0 ~ 100.00%	
P9.15	Motor data identification	0	0 ~ 2	/	×	0: No action 1: Motor data identification at standstill 2: Complete motor data identification	

No.	Name	Default	Range	Unit	Property	Description	User
P9.16	Motor overload protection	00	00 ~ 12	/	×	Ones place: Protection mode: 0: Motor current mode 1: Sensor mode 2: Inactive Tens place: Low speed de-rated: 0: Active 1: Inactive	
P9.17	Motor over temperature protection threshold	10.00	0.00 ~ 10.00	V	×	0.00 ~ 10.00V	
P9.18	Motor overload protection time	10.0	0.5 ~ 30.0	min	×	0.5 ~ 30.0min	
Group PA Control Parameters							
PA.00	Switching frequency (E5-H)	8.0 4.0 3.0 2.0	0.7 ~ 16.0	kHz	○	15kW and below power class : 0.7kHz ~ 16.0kHz 18.5kW ~ 45kW power class : 0.7kHz ~ 10.0kHz 55kW ~ 75kW power class: 0.7kHz ~ 8.0kHz 90kW and above power class: 0.7kHz ~ 3.0kHz	
	Switching frequency (E5-A)	8.0 4.0 3.0 2.0	0.7 ~ 16.0	kHz	○	15kW ~ 18.5kW power class : 0.7kHz ~ 16.0kHz 22kW ~ 55kW power class : 0.7kHz ~ 10.0kHz 75kW ~ 90kW power class: 0.7kHz ~ 8.0kHz 110kW and above power class: 0.7kHz ~ 3.0kHz	
PA.01	Switching frequency automatic adjustment (E5-H)	1	0 ~ 1	/	○	0: No auto adjustment 1: Auto adjustment	
	Switching frequency automatic adjustment (E5-A)	0	0 ~ 1	/	○	0: No auto adjustment 1: Auto adjustment	
PA.02	Slip compensation	100.0	0.0 ~ 300.0	%	○	0.0 ~ 300.0%	
PA.03	Droop control	0.00	0.00 ~ 10.00	Hz	○	0.00 ~ 10.00Hz	
PA.04	Current limit selection	1	0 ~ 1	/	×	0: Disabled 1: Enabled	
PA.05	Current limit level	160.0	20.0 ~ 200.0	%	×	E5-H: 20.0 ~ 200.0%, default value is 160.0% E5-A: 20.0 ~ 150.0%, default value is 120.0%	
PA.06	Auto voltage regulation	101	000 ~ 111	/	×	Ones place: Over voltage regulation 0: Disabled 1: Enabled Tens place: Under voltage regulation 0: Disabled 1: Enabled Hundreds place: Over modulation 0: Disabled 1: Enabled	
PA.07	Energy saving rate	0	0 ~ 50	%	○	0 ~ 50%	
PA.08	Magnetic flux braking selection	1	0 ~ 1	/	×	0: Disabled 1: Enabled	
PA.09	Dynamic braking selection	0	0 ~ 1	/	×	0: Disabled 1: Enabled	
PA.10	Braking unit hysteresis voltage	0	0 ~ 30	V	×		
PA.11	Braking unit action voltage	720	650 ~ 750	V	×	650 ~ 750V	
PA.12	Special fault activated selection	100	000 ~ 111	/	×	Ones place: Under voltage fault 0: Disabled 1: Enabled Tens place: During automatic reset 0: Disabled 1: Enabled Hundreds place: Fault locking 0: Disabled 1: Enabled	

No.	Name	Default	Range	Unit	Property	Description	User
PA.13	Inverter or motor overload pre-alarm	000	000 ~ 111	/	×	Ones place: Detected mode selection: 0: Motor overload pre-alarm, relative to motor rated current 1: Inverter overload pre-alarm, relative to inverter rated current Tens place: Action after overload pre-alarm: 0: Continue running 1: Report overload fault and stop Hundreds place: Detecting condition selection 0: Detect all the time 1: Only detect at constant speed	
PA.14	Overload pre-alarm detection level	130.0	20.0 ~ 200.0	%	×	20.0 ~ 200.0%	
PA.15	Overload pre-alarm detection time	5.0	0.1 ~ 60.0	s	×	0.1 ~ 60.0s	
PA.16	Faults shield and alarm attribute setting 1	0020	0000 ~ 2222	/	×	Ones place: Motor or motor output cable is short circuited to ground	
						Tens place: Power supply is switched off during running process	
						Hundreds place: Power supply is abnormal	
						Thousands place: Output phase loss	
PA.17	Faults shield and alarm attribute setting 2	0020	0000 ~ 2222	/	×	Ones place: EEPROM fault	
						Tens place: Pre-charging contactor fault	
						Hundreds place: Temperature sensor abnormal	
						Thousands place: Encoder disconnection	
PA.18	Faults shield and alarm attribute setting 3	2000	0000 ~ 2222	/	×	Ones place: +10V output error	
						Tens place: Analog input error	
						Hundreds place: Motor over temperature(PTC)	
						Thousands place: Communication fault 1 (operation panel 485)	
PA.19	Faults shield and alarm attribute setting 4	0002	0000 ~ 2222	/	×	Ones place: Communication fault 2 (terminal 485)	
						Tens place: Software version incompatible	
						Hundreds place: Reserve	
						Thousands place: Reserve	
PA.20	Fault locking function selection	0	0 ~ 1	/	×	0: Fault is not locked 1: Fault is locked	
PA.21	Automatic reset times	0	0 ~ 20	/	×	0 ~ 20	
PA.22	Automatic reset interval	2.0	2.0 ~20.0	s	×	2.0 ~ 20.0s	
Group Pb Enhanced Function Parameters							
Pb.00	Jump frequency 1 lower limit	0.00	0.00 ~ 300.00	Hz	×	Upper/ lower frequency limit (P0.13 ~ P0.14)	
Pb.01	Jump frequency 1 upper limit	0.00	0.00 ~ 300.00	Hz	×	Upper/ lower frequency limit (P0.13 ~ P0.14)	
Pb.02	Jump frequency 2 lower limit	0.00	0.00 ~ 300.00	Hz	×	Upper/ lower frequency limit (P0.13 ~ P0.14)	
Pb.03	Jump frequency 2 upper limit	0.00	0.00 ~ 300.00	Hz	×	Upper/ lower frequency limit (P0.13 ~ P0.14)	
Pb.04	Jump frequency 3 lower limit	0.00	0.00 ~ 300.00	Hz	×	Upper/ lower frequency limit (P0.13 ~ P0.14)	
Pb.05	Jump frequency 3 upper limit	0.00	0.00 ~ 300.00	Hz	×	Upper/ lower frequency limit (P0.13 ~ P0.14)	

No.	Name	Default	Range	Unit	Property	Description	User
Pb.06	UP/DN single step frequency setting without integral function	0.10	0.00 ~ 10.00	Hz	○	0.00 ~ 10.00Hz	
Pb.07	Magnification acceleration/ deceleration time and UP/DN change direction selection	1000	0000 ~ 1111	/	×	Ones place: Acceleration / deceleration time: 0: X1 1: X10 Tens place: Reserved Hundreds place: Reserved Thousands place: UP/DN change direction: 0: Change running direction is enabled 1: Change running direction is disabled	
Pb.08	Operation panel \wedge/\vee digital regulating frequency control	0001	0000 ~ 1221	/	○	Ones place: Save operation panel \wedge/\vee setting frequency after power off 0: Save after power off 1: Clear after power off Tens place: Save operation panel \wedge/\vee setting frequency after stop 0: Save after stop 1: Clear after receive a stop command 2: Clear in stop status Hundreds place: Operation panel \wedge/\vee enabled: 0: Only enabled when main reference is P0.05 1: Always enabled 2: Always disabled Thousands place: Integral function selection 0: With integral function 1: Without integral function	
Pb.09	Operation panel \wedge/\vee integral rate	2.0	0.1 ~ 50.0	s	○	0.1 ~ 50.0s	
Pb.10	Terminal UP/DN digital regulating frequency control	0001	0000 ~ 1221	/	○	Ones place: Save terminal UP/DN setting frequency after power off 0: Save after power off 1: Clear after power off Tens place: Save terminal UP/DN setting frequency after stop 0: Save after stop 1: Clear after receive a stop command 2: Clear in stop status Hundreds place: Terminal UP/DN enabled: 0: Only enabled when main reference is P0.05 1: Always enabled 2: Always disabled Thousands place: Integral function selection 0: With integral function 1: Without integral function	
Pb.11	Terminal UP/DN integral rate	2.0	0.1 ~ 50.0	s	○	0.1 ~ 50.0s	
Pb.12	Reach pre-set running time action selection	00	00 ~ 11	/	○	Ones place: Reach continuous running time 0: Continue running 1: Stop and alarm Tens place: Reach accumulative running time 0: Continue running 1: Stop and alarm	
Pb.13	Continuous running time setting	0.0	0.0 ~ 6553.5	min	○	0.0~6553.5	
Pb.14	Accumulative running time setting	0.0	0.0 ~ 6553.5	min	○	0.0~6553.5	
Pb.15	Automatic restart	0	0 ~ 1	/	×	0: Disabled 1: Enabled	
Pb.16	Automatic restart waiting time	0.5	0.0 ~ 20.0	s	○	0.0 ~ 20.0s	

No.	Name	Default	Range	Unit	Property	Description	User
Pb.17	Preset frequency	0.00	0.00 ~ 300.00	Hz	○	0.00 ~ 300.00Hz	
Pb.18	Preset frequency operating time	0.0	0.0 ~ 3600.0	s	○	0.0 ~ 3600.0s	
Pb.19	Wake-up frequency	0.00	0.00 ~ 300.00	Hz	○	0.00 ~ 300.00Hz	
Pb.20	Sleep frequency	0.00	0.00 ~ 300.00	Hz	○	0.00 ~ 300.00Hz	
Pb.21	Fan and pump control mode selection	0	0 ~ 3	/	○	0: Basic running mode 1: Pre-overload decelerate frequency mode 2: Forced energy saving mode 1(square type load) 3: Force energy saving mode 2(cube type load)	
Pb.22	Forced energy saving rate reference	10	0.0 ~ 50.0	%	○	Only enabled when Pb.21=2 or Pb.21=3	
Pb.23	Parameters copy	0	0 ~ 5	/	×	0: No function 1: Parameter upload 2: Parameter download (without motor parameters) 3: Parameter download (with motor parameters) 4: Parameter upload is not allowed 5: Parameter upload is allowed	
Group PC Communication Parameters							
PC.00	Communication baud rate	5	4 ~ 8	bps	○	4: 4800 bps 5: 9600 bps 6: 19200 bps 7: 38400 bps 8: 57600 bps	
PC.01	Data format	0	0 ~ 2	/	○	0: 1-8-1 format, no parity 1: 1-8-1 format, even parity 2: 1-8-1 format, odd parity	
PC.02	Local address	1	1 ~ 247	/	○	1 ~ 247, 0 is broadcasting address	
PC.03	Communication parameters setting	303	303 ~ F0F	/	○	Ones place: Terminal RS485 setting bit0=0: Without reply bit0=1: Reply if communication with host computer bit1=0: Will not reply if communication disconnected bit1=1: Reply if communication disconnected bit2=0: Communication will not detect password bit2=1: Communication will detect password bit3=0: 0x06 and 0x10 command communication write RAM bit3=1: 0x06 and 0x10 command communication write EEPROM Tens place: Reserved Hundreds place: Operation panel RS485 setting: same as ones place	
PC.04	Master-slave mode	0	0 ~ 2	/	○	0: SCIA slave mode, SCIB slave mode 1: SCIA master mode, SCIB slave mode 2: SCIA slave mode, SCIB master mode	
PC.05	Operating address from master to slave	0	0 ~ 2	/	○	The parameter is setting in master 0: P0.05 1: P8.00 2: P8.01	
PC.06	Slave received value proportional	1.00	0.00 ~ 10.00	/	○	The parameter is setting in slave	

No.	Name	Default	Range	Unit	Property	Description	User
Group PE Controlled by Manufacture Parameters 1							
PE.00 ~ PE.06	Reserved	-	0000 ~ FFFF	/	○		
PE.07	Oscillation suppression parameter 1	0004	0 ~ 65535	/	○		
PE.08	Oscillation suppression parameter 2	0.010	0 ~ 65.535	/	○		
PE.09 ~ PE.22	Reserved	-	0000 ~ FFFF	/	○		
PE.23	AI1 zero drift correction	2048	0 ~ 65535	/	○	2048 correspond to 0V	
PE.24	AI2 zero drift correction	2055	0 ~ 65535	/	○	2048+7 correspond to 0.02V	
PE.25	AI3 zero drift correction	2055	0 ~ 65535	/	○	2048+7 correspond to 0.02V	
PE.26	Parameter save selection after power off	0	0 ~ 1	/	○	0: Parameter save after power off is active 1: Parameter save after power off is inactive	
Group d0 Fault Record Parameters							
d0.00	Fault record 2	0	0 ~ 62	/	*	Refer to chapter 7	
d0.01	Fault record 1	0	0 ~ 62	/	*		
d0.02	Fault record 0 (latest)	0	0 ~ 62	/	*		
d0.03	Bus voltage of latest fault	0	0 ~ 65535	V	*	0 ~ 65535V	
d0.04	Current of latest fault	0.0	0.0 ~ 6553.5	A	*	0.0 ~ 6553.5V	
d0.05	Running frequency of latest fault	0.00	0.00 ~ 300.00	Hz	*	0.00 ~ 300.00Hz	
d0.06	Accumulative power on time	0.000	0 ~ 65.535	kh	*	0.000 ~ 65.535kh	
d0.07	Accumulative running time	0.000	0 ~ 65.535	kh	*	0.000 ~ 65.535kh	
d0.08	Heat-sink maximum temperature record	0.0	0.0 ~ 100.0	°C	*	0.0 ~ 100.0°C	
d0.09	Bus voltage maximum fluctuation record	0	0 ~ 1000	V	*	0 ~ 1000V	
d0.10	Reserved	0.00	0.00 ~ 300.00	Hz	*	0.00 ~ 300.00Hz	
d0.11	E.FAL protection type	0	0 ~ 5	/	*	0: None 1: Module protection 2: Over current 3: Over voltage 4: Short circuited to ground 5: Vagueness state, interfere and all of above are possible	
Group d1 Product Identity Parameters							
d1.00	Serial number	Factory	0.0 ~ FFFF	/	*	0 ~ FFFF	
d1.01	Software version of control board	Factory	0.00 ~ 99.99	/	*	0.0 ~ 99.99	
d1.02	Software non-standard version of control board	Factory	0.00 ~ FF.FF	/	*	0.00 ~ FF.FF	
d1.03	Software version of operation panel	Factory	0.000 ~ F.FFF	/	*	0.000 ~ F.FFF	

No.	Name	Default	Range	Unit	Property	Description	User
d1.04	Software version of extension card	Factory	0.000 ~ F.FFF	/	*	0.000 ~ F.FFF	
d1.05	Manufacture bar code 1	Factory	0 ~ 9999	/	*	0 ~ 9999	
d1.06	Manufacture bar code 2	Factory	0 ~ 9999	/	*	0 ~ 9999	
d1.07	Manufacture bar code 3	Factory	0 ~ 9999	/	*	0 ~ 9999	
d1.08	Manufacture bar code 4	Factory	0 ~ 9999	/	*	0 ~ 9999	
d1.09	Operation panel copy identification code	Factory	0.00 ~ 655.35	/	*	0.00 ~ 655.35	
d1.10	Control board software identification code	Factory	0 ~ 65535	/	*	0 ~ 65535	
d1.11	Reserved	Factory	0 ~ 65535	/	*	0 ~ 65535	
Group d2 Display Parameters							
d2.00	Heat-sink 1 temperature	0.0	0.0 ~ 100.0	°C	*	0.0 ~ 100.0°C	
d2.01	Terminal count value	0	0 ~ 65535	/	*	0 ~ 65535	
d2.02	AI1 percentage after curve transformation	0.0	0.0 ~ 100.0	%	*	0.0 ~ 100.0%	
d2.03	AI2 percentage after curve transformation	0.0	0.0 ~ 100.0	%	*	0.0 ~ 100.0%	
d2.04	AI3 percentage after curve transformation	0.0	0.0 ~ 100.0	%	*	0.0 ~ 100.0%	
d2.05	DI percentage after curve transformation	0.0	0.0 ~ 100.0	%	*	0.0 ~ 100.0%	
d2.06	Operation panel \wedge/\vee adjustment value	0	0 ~ 65535	/	*	0 ~ 65535	
d2.07	Terminal UP/DN adjustment value	0	0 ~ 65535	/	*	0 ~ 65535	
d2.08	Software compile date	Factory	0 ~ FFFF	/	*	0~FFFF	
d2.09	Xi terminal status display	0000	0 ~ FFFF	/	*	0: OFF 1: ON bit0: X1 bit1: X2 bit2: X3 bit3: X4 bit4: X5 bit5: X6 bit6: X7	
d2.10	Reference voltage 1 (percentage)	Factory	0.0 ~ 100.0	%	*	0.0~100.0%	
d2.11	Reference voltage 2 (percentage)	Factory	0.0 ~ 100.0	%	*	0.0~100.0%	
d2.12	AI fault source display	Factory	0 ~ 5	/	*	1: AI1 exceeding limit 2: AI2 exceeding limit 3: AI3 exceeding limit 4: AV4/AI4 exceeding limit 5: AV5/AI5 exceeding limit	
d2.13	Output current detection fault source display	Factory	0 ~ 6	/	*	2: Phase W abnormal 4: Phase V abnormal 6: Phase U abnormal	
d2.14	Frequency correspond to motor rotation speed	0.00	0 ~ 655.35	Hz	*	0 ~ 655.35Hz	
d2.15 ~ d2.27	Reserved	Factory	0 ~ 65535	/	*	0 ~ 65535	

No.	Name	Default	Range	Unit	Property	Description	User
Group H0 Special Parameters for Constant Pressure Control							
H0.00	Process closed loop function selection for constant pressure control	0	0 ~ 1	/	×	0: Disabled 1: Enabled	
H0.01	The pressure corresponding to maximum analog	1.00	0.00 ~ 655.35	Mpa	×	0.00 ~ 655.35 Mpa	
H0.02	Upper limit of pressure setting	1.00	0.00 ~ 655.35	Mpa	×	0.00 ~ 655.35 Mpa	
H0.03	Lower limit of pressure setting	0.00	0.00 ~ 655.35	Mpa	×	0.00 ~ 655.35 Mpa	
H0.04	Pressure setting channel selection	0	0 ~ 2	/	○	0: Digital pressure setting (H0.05) 1: AI1 2: AI2	
H0.05	Digital pressure setting	0.40	0.00 ~ 655.35	Mpa	○	0.00 ~ 655.35Mpa(when H0.04=0)	
H0.06	Sleep frequency setting	30.00	0.0 ~ 300.00	Hz	○	0.0 ~ 300.00Hz	
H0.07	Sleep delay time	60.0	0.0 ~ 3600.0	s	○	0.0 ~ 3600.0s	
H0.08	Wake-up pressure percentage	50.0	0.0 ~ 200.0	%	○	0.0 ~ 200.0%	
H0.09	Exit wake-up delay time	30.0	0.0 ~ 3600.0	s	○	0.0 ~ 3600.0s	
H0.10	Reserved	0	/	/	*	Reserved	
H0.11	Frequency of auto switch acceleration time and deceleration time	0.00	0.00 ~ 300.00	Hz	○	0.00 ~ 300.00Hz	
H0.12	Acceleration time and deceleration time automatically switch selection	1	0 ~ 3	s	○	0: Acceleration time and deceleration time 0 (P0.08 and P0.09) 1: Acceleration time and deceleration time 1 (P4.09 and P4.10) 2: Acceleration time and deceleration time 2 (P4.11 and P4.12) 3: Acceleration time and deceleration time 3 (P4.13 and P4.14)	
H0.30	Sleep and wake-up mode selection	0	0 ~ 1	/	○	0: According H0.00 setting 1: According H0.31 to H0.34 setting	
H0.31	Wake-up pressure setting	0.00	0.0 ~ 10.00	V	○	0.00 ~ 10.00V	
H0.32	Sleep pressure setting	0.00	0.0 ~ 10.00	V	○	0.00 ~ 10.00V	
H0.33	Wake-up delay time	0.0	0.0 ~ 3600.0	s	○	0.0 ~ 3600.0s	
H0.34	Sleep delay time	0.0	0.0 ~ 3600.0	s	○	0.0 ~ 3600.0s	
Group H1 Special Parameters for EX-DT01 Digital Terminal Extension Card							
H1.00	EX-DT01 digital terminal extension card selection	1	0 ~ 1	/	○	0: EX-DT01 is not selected 1: EX-DT01 is selected	
H1.01	Digital input terminal X8 function selection	99	00 ~ 99	/	○	Refer to the description of P5.00 to P5.06	
H1.02	Digital input terminal X9 function selection	99	00 ~ 99	/	○		
H1.03	Digital input terminal X10 function selection	99	00 ~ 99	/	○		
H1.04	Digital input terminal X11 function selection	99	00 ~ 99	/	○		
H1.05	X8~X11 terminal filter time	0.001	0.000 ~ 1.000	s	○		
H1.06	X8~X11 virtual terminal active selection	0	0 ~ 1	/	○	0: X8 ~ X11 virtual terminal is inactive 1: X8 ~ X11 virtual terminal is active	

No.	Name	Default	Range	Unit	Property	Description	User
H1.07	X8~X11 terminal positive logic or negative logic selection	0	0 ~ F	/	○	0: Positive logic is active 1: Negative logic is active bit0: X8 positive logic or negative logic selection bit1: X9 positive logic or negative logic selection bit2: X10 positive logic or negative logic selection bit3: X11 positive logic or negative logic selection	
H1.08	Relay RA1 output function selection	00	00 ~47	/	○	Refer to the description of parameter P7.02	
H1.09	Relay RA2 output function selection	01	0 ~47	/	○		
H1.10	Relay RA3 output function selection	02	0 ~47	/	○		
H1.11	RA1~RA3 virtual terminal active selection	0	0 ~ 1	/	○	0: RA1 ~ RA3 virtual terminal is inactive 0: RA1 ~ RA3 virtual terminal is active	
H1.12	RA1~RA3 terminal positive logic or negative logic selection	0	0 ~ 7	/	○	0: Positive logic is active 1: Negative logic is active bit0: RA1 positive logic or negative logic selection Bit1: RA2 positive logic or negative logic selection Bit2: RA3 positive logic or negative logic selection	
H1.13	RA1 output function action delay time	0.0	0.0 ~ 999.9	s	○		
H1.14	RA2 output function action delay time	0.0	0.0 ~ 999.9	s	○		
H1.15	RA3 output function action delay time	0.0	0.0 ~ 999.9	s	○		
Group A0 Controlled by Manufacture Parameters 2							
A0.00	Reserved	0000	0000 ~ FFFF	/	○	0000 ~ FFFF	
A0.01	X1 ~ X7, A1 ~ A13 terminal positive logic or negative logic selection	03FF	0000 ~ FFFF	/	○	0: Negative logic is active 1: Positive logic is active bit0: X1 positive logic or negative logic selection bit1: X2 positive logic or negative logic selection bit2: X3 positive logic or negative logic selection bit3: X4 positive logic or negative logic selection bit4: X5 positive logic or negative logic selection bit5: X6 positive logic or negative logic selection bit6: X7 positive logic or negative logic selection bit7: A1 positive logic or negative logic selection bit8: A12 positive logic or negative logic selection bit9: A13 positive logic or negative logic selection	
A0.02	Reserved	0	0 ~ 2	/	○	Reserved	
A0.03	Auxiliary reference limit percentage	100.0	0.0 ~ 100.0	%	○	0.0 ~ 100.0%	
A0.04 ~ A0.12	Reserved	FFFF	0000 ~ FFFF	/	○	0000 ~ FFFF	
C0.00	Reserved	-	0 ~ 65535	/	*	0 ~ 65535	
U0.00	Reserved	-	0 ~ 65535	/	*	0 ~ 65535	
U1.00	Reserved	-	0 ~ 65535	/	*	0 ~ 65535	

Chapter 6 Parameter Descriptions

6.1 Basic Function Parameters (Group P0)

P0.00	User password	0000 ~ FFFF (0000)
-------	---------------	--------------------

In order to prevent the irrelevant personnel from querying and changing the parameters, and protect your know-how, it is possible to restrict access to the parameters by setting user password.

No password protection by default, All the parameters in Zone P can be queried and changed.

Setting password:

Enter four digits as user password, and press PRG key for confirmation. Repeat this operation once again. When "P.Set" is displayed, the password is successfully set.

Change password:

Press PRG key to enter the password verification status, and "0.0.0.0." is displayed. Enter correct password, and it enters parameter editing status. Select P0.00 (parameter P0.00 displayed as 0000) and then enter new password and press PRG key for confirmation. Set the same password for P0.00 twice. When "P.Set" is displayed, the new password is successfully set.

Cancel password:

Press PRG key to enter the password verification status, and "0.0.0.0." is displayed. Enter correct user password to enter the parameter editing status, check if P0.00 is 0000. Press PRG key for confirmation, and set P0.00=0000 again, and then "P.Clr" is displayed and the password is canceled.

Note:

For the method of activating the password, refer to 4.5 Password Operation in Chapter 4.

P0.01	Parameters protection	0 ~ 5(0)
-------	-----------------------	----------

This parameter is used to set the modification authority and initialization level of the parameters.

0: All the parameters are allowed for modification.

1: All the parameters are disallowed for modification.

2: Restore all the parameters in zone P to factory setting.

3: Restore all the parameters in zone P to factory setting except for the motor parameters (group P9).

4: Restore all the parameters in zone P and zone A to factory setting.

5: Restore all the parameters to factory setting except group d.

Note:

The password P0.00 will be cleared after the parameters are restore to factory setting.

P0.02	Parameters display mode	0 ~ 3(0)
-------	-------------------------	----------

This parameter is use to set parameters display mode to improve the work efficiency according to actual requirement of the work-site.

0: Basic menu mode: The operation panel can display all the parameters.

1: Fast menu mode: The operation panel only display the fast parameters defined by the manufacturer.

2: Non factory setting menu mode: The operation panel only display the parameters different from the factory setting.

Note:

- After commissioning is completed, to conveniently record and query the modified parameters.
- When perform on-site maintenance, to conveniently record and query the modified parameters.
- 3: Last changed 10 parameters menu mode: The last changed 10 parameters can be inquired.

Note:

- Both P0.00 and P0.02 are visible in all menu modes for the convenience of menu mode switched.
- Press ESC key and hold for over 5 seconds, it will restore to basic menu mode, and P0.02 is automatically restored to 0.
- In non-basic menu mode, the >> key cannot be used to switch the parameter and group number. The current menu mode will be displayed after pressing the >> key for 5 times.

P0.03

Control mode

0 ~ 3(0)

The parameter is used to set the motor control mode.

0: Process open loop control:

It is applicable to most applications, including the application of multiple motor with a single inverter (the motors are in the same work conditions, such as gantry of crane).

1: Analog feedback process close loop control:

This function can be used for closed loop control of system variables such as pressure, temperature, etc. The difference between the reference and the feedback value is fed into the PID controller. The PID controller adjusts the output frequency in order to minimize the deviation of reference and feedback, providing accurate control of system variables.

For the reference setting and feedback setting of the analog feedback process close loop control, refer to the descriptions of P1.02~P1.07.

AI1 and AI2 analog input specification: 0~10V or 0~20mA.

AI3 analog input specification: -10~10V.

X7/DI pulse input specification: 0~ maximum input pulse frequency P5.10.

For the setting of the process PID close loop, refer to parameter descriptions in Group P8 .

2: Single-phase pulse feedback process close loop control:

It is applicable to applications with higher speed control precision, and pulse encoder shall be installed.

Single-phase pulse feedback channel is X7/DI terminal, The X7/DI terminal function must be set to process close loop control single-phase pulse input (P5.06=47) .

3: Composite control:

The composite control of process open loop and analog feedback closed loop is suitable for special applications. When the inverter running in setting frequency of open loop, and it is necessary to use process close loop control in the system, and the process close loop adjustment result will be added to the open loop frequency reference of the inverter, so as to ensure the constancy of the physical parameter through speed control. Refer to parameter P1.08.

Note:

- AI3 is only available for "E5-H-4T**G-63", "E5-H-4T**G-34" non-standard series and E5-A series.
- Pulse input X7/DI is only available for "E5-H-4T**G-63" non-standard series and E5-A series.

P0.04	Open loop main reference channel	0 ~ 4(0)
P0.05	Open loop digital frequency reference	0.00 ~ 300.00 Hz (50.00Hz)

This function is applicable to the frequency reference of open loop control mode (P0.03=0).

For the process close loop control (P0.03=1/2/3), refer to the parameter descriptions of P1.02 ~ P1.08.

0: Frequency reference is P0.05.

Note:

➤ If multi-step digital voltage terminals 1 ~ 3 are enabled, the frequency is determined by the terminal combinations. Refer to P4.15 ~ P4.21.

➤ If multi-step frequency terminals 1 ~ 4 are enable, the frequency is determined by the terminal combinations. Refer to P4.22~P4.36.

1: Frequency reference is AI1.

2: Frequency reference is AI2.

AI1 and AI2 analog input specification is 0~10V or 0~20mA. The correspondence relation between the analog value and the reference frequency is defined by Group P6.

3: Frequency reference is AI3.

AI3 analog input specification is -10~10V. The correspondence relation between the analog value and the reference frequency is defined by group P6. The operation direction is determined by the sign of the AI3 analog input.

4: Frequency reference is X7/DI

X7/DI pulse input specification: 0~maximum pulse frequency P5.10. The correspondence relation between the pulse signal and the reference frequency is defined by group P6.

Note:

➤ AI3 is only available for "E5-H-4T**G-63", "E5-H-4T**G-34" non-standard series and E5-A series.

➤ Pulse input X7/DI is only available for "E5-H-4T**G-63" non-standard series and E5-A series.

➤ When P0.04=4, the X7/DI terminal function must be set to pulse frequency DI input (P5.06=5).

P0.06	Run command channel selection	0 ~ 2(0)
-------	-------------------------------	----------

There are three run command channel selection.

0: Operation panel mode: Perform the run, stop, forward or reverse running through the RUN, STOP/RST and FWD/REV keys of the operation panel.

1: Terminal: Perform the run, stop, forward or reverse running by defining the multi-function terminals X1~X7. Refer to the description of P5.00~P5.06 and P5.11.

2: Host computer: Perform the run, stop, forward or reverse running through communication. Refer to the appendix A Modbus communication protocol.

P0.07	Running direction command	0 ~ 1(0)
-------	---------------------------	----------

This parameter is used to change the running direction of the motor.

0: Forward

1: Reverse

Note: This parameter is enabled only when the run command channel is operation panel (P0.06=0).

P0.08	Acceleration time 0	0.1 ~ 3600.0 s (6.0s or 20.0s)
P0.09	Deceleration time 0	0.1 ~ 3600.0 s (6.0s or 20.0s)
P0.10	S curve time	0.0 ~ 60.0 s (0.0s)

These parameters are used to set the acceleration time and deceleration time for acceleration and deceleration.

Acceleration time 0: The time that accelerates from 0 to maximum frequency (P0.11).

Deceleration time 0: The time that decelerates from maximum frequency (P0.11) to 0.

S curve time: The time for S curve is used to improve the smoothness characteristic of the start and stop during acceleration and deceleration, P0.10 S curve time is applicable to smooth acceleration and deceleration to minimize abrupt shock to the load, such as the belt conveyor that carries fragile materials.

When P0.10=0, it indicates without S curve time, the acceleration and deceleration is in linear mode.

$$\text{Actual acceleration time} = P0.08 * \text{reference frequency} / P0.11$$

$$\text{Actual deceleration time} = P0.09 * \text{reference frequency} / P0.11$$

When P0.10 is set to a non-zero, it indicates that there is S curve time, and the acceleration and deceleration adopts S curve mode.

$$\text{S curve time} = P0.10 * \text{setting frequency} / P0.11$$

$$\text{Actual S curve acceleration time} = \text{Actual acceleration time} + \text{S curve time}$$

$$\text{Actual S curve deceleration time} = \text{Actual deceleration time} + \text{S curve time}$$

As shown in the following figure, curve 1 is the curve representing the acceleration/deceleration in linear mode, curve 2 is the curve representing the acceleration/deceleration in S curve mode.

Curves 1 and 2 corresponding to the same setting frequency. The actual acceleration/deceleration time of curve 2 is longer than that of curve 1 by the time set by P0.10.

Note:

- The S curve time setting is also available for acceleration/deceleration time 1, 2 and 3 (P4.09~P4.14).
- It is suggest setting the S curve time is 1/5 of the acceleration/deceleration time.

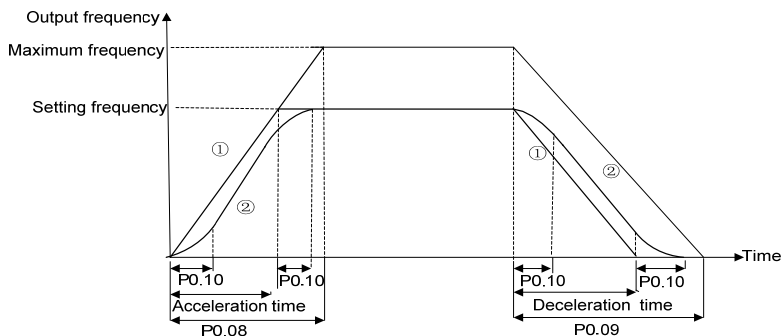

Figure6-1 Acceleration/deceleration time and S curve

P0.11	Maximum output frequency	0.01 ~ 300.00 Hz (50.00Hz)
P0.12	Maximum output voltage	1 ~ 480 V (380V)
P0.13	Frequency upper limit	0.00 ~ 300.00 Hz (50.00Hz)
P0.14	Frequency lower limit	0.00 ~ 300.00 Hz (0.00Hz)
P0.15	Basic operating frequency	0.00 ~ 300.00 Hz (50.00Hz)

The maximum output frequency f_{max} is the allowable maximum output frequency of the inverter.

The maximum output voltage V_{max} is the output voltage when the inverter runs at basic operating frequency. When standard AC motor is used, it corresponds to the motor rated voltage. The parameter value should from the motor nameplate.

The frequency upper limit f_H and frequency lower limit f_L are the maximum and minimum operating frequency of the motor, the setting should according to the production process requirement.

The basic operating frequency f_b is the minimum frequency corresponding to the maximum output voltage of the inverter. When standard AC motor is used, it corresponds to the motor rated frequency. The parameter value should from the motor nameplate.

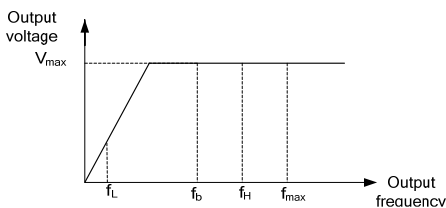

Figure6-2 Characteristic parameter definition

P0.16	Torque boost	0.0 ~ 30.0 % (0.0%)
-------	--------------	---------------------

The parameter is used to increase the output voltage, and offset the stator voltage drop to improve the torque performance at low speed.

If P0.16 is set to "0", represents the current torque boost is automatic torque boost.

If P0.16 is set to non-zero value, represents the current torque boost is manual torque boost.

Note:

- The torque boost setting should be set according to the load situation. The value setting too large the motor would be over temperature, tripped by over-current or over-load.
- When P0.16 is set to 0.0, and P4.00 is set to 0 (linear V/F curve), the automatic torque boost is enabled; when P4.00 is set to a non-zero value, the automatic torque boost is disabled.

6.2 Main and Auxiliary Reference Parameters (Group P1)

P1.00	Open loop auxiliary frequency reference channel	00 ~ 14(00)
P1.01	Open loop main frequency reference and auxiliary frequency reference calculation formula	0 ~ 5(0)

In process open loop control mode, the main reference value f_m can be added with an auxiliary reference value f_a , and it results process open loop frequency reference f_{com} .

Such calculations as "add", "subtract", "bias", "max" and "min" are available for main reference value f_m and auxiliary reference value f_a .

The auxiliary reference range can be changed to realize the fine tuning function through curve correction, refer to parameter P6.00.

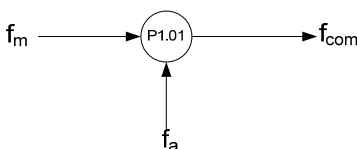

Figure6-3 Open loop main and auxiliary reference combination

P1.00 Open loop auxiliary reference channel	
Ones place	Auxiliary reference channel selection: 0: None 1: AI1 2: AI2 3: AI3 4: DI
Tens place	Auxiliary reference max. limit selection: 0: P0.11, auxiliary reference 0 ~ 100% corresponding to 0 ~ P0.11 1: Main reference, auxiliary reference 0 ~ 100% corresponds to 0 ~ main reference

The parameter P1.01 is used to define the main reference frequency and auxiliary reference frequency calculation formula.

0: Main reference + auxiliary reference: The auxiliary frequency reference value is superimposed on the main reference, the function is "add".

1: Main reference - auxiliary reference: The auxiliary frequency reference value is superimposed on the main reference, the function is "subtract".

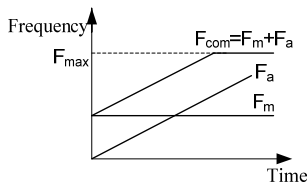

Figure6-4 Main reference + auxiliary reference

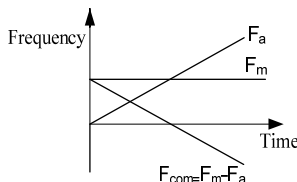

Figure6-5 Main reference - auxiliary reference

- 2: Auxiliary reference-50%: The auxiliary reference value subtracts the bias equal to 50% of the auxiliary reference full range value. The main reference value is disable at this calculation formula.
- 3: Main reference + auxiliary reference-50%: The auxiliary reference value subtracts the bias equal to 50% of the auxiliary reference full range value and then superimposes on the main reference.

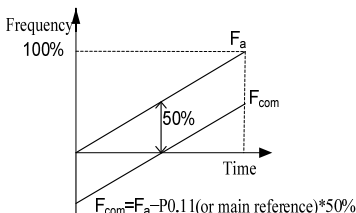

Figure6-6 Auxiliary reference - 50%

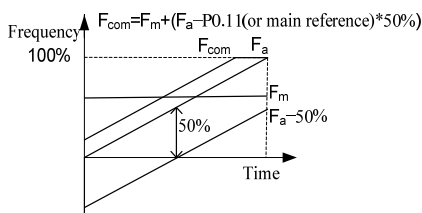

Figure6-7 Main reference + auxiliary reference - 50%

- 4: Max: Get the maximum value of the main reference f_m and the auxiliary reference f_a .
- 5: Min: Get the minimum value of the main reference f_m and the auxiliary reference f_a .

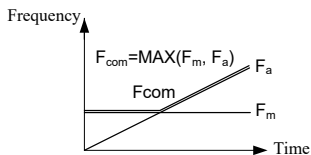

Figure6-8 Take maximum value

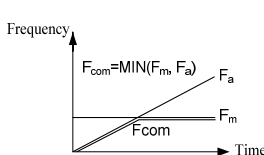

Figure6-9 Take minimum value

Note:

When the corresponding frequency of the combination value f_{com} exceeds the frequency upper or lower limit, the output frequency will be restricted to the upper or lower limit.

P1.02	Analog feedback close loop control main reference channel	0 ~ 4(0)
P1.03	Analog feedback close loop control auxiliary reference channel	0 ~ 4(0)
P1.04	Analog feedback close loop control main reference and auxiliary reference calculation formula	0 ~ 5(0)

In analog feedback close loop system, digital voltage setting, analog and pulse can be set as main reference channel; analog and pulse can be set as auxiliary reference channel.

The parameter P1.02 is used to set the main reference channel of process close loop control:

- 0: P8.00 setting 1: AI1 2: AI2 3: AI3 4: DI

The parameter P1.03 is used to set the auxiliary reference channel of process close loop control:

- 0: None 1: AI1 2: AI2 3: AI3 4: DI

The parameter P1.04 is used to set the main reference and auxiliary reference calculation formula of process close loop control:

- 0: Main + auxiliary 1: Main - auxiliary 2: Auxiliary -50% 3: Main+ auxiliary-50%
- 4: Maximum 5: Minimum

The main reference and auxiliary reference calculation for close loop to the same as the main reference and auxiliary reference calculation function for open loop. For details, refer to the description of P1.01.

P1.05	Analog feedback close loop control main feedback channel	1 ~ 4(1)
P1.06	Analog feedback close loop control auxiliary feedback channel	0 ~ 4(0)
P1.07	Analog feedback close loop control main feedback and auxiliary feedback calculation formula	0 ~ 5(0)

In analog feedback close loop system, analog and pulse can be set as main feedback channel and auxiliary feedback channel.

The main feedback and auxiliary feedback calculation function for process close loop feedback to the same as the main reference and auxiliary reference calculation function for process close loop reference. For details, refer to the description of P1.01.

The parameter P1.05 is used to set the main feedback channel of process close loop control:

- 1: AI1 2: AI2 3: AI3 4: DI

The parameter P1.06 is used to set the auxiliary feedback channel of process close loop control:

- 0: None 1: AI1 2: AI2 3: AI3 4: DI

The parameter P1.07 is used to set the main feedback and auxiliary feedback calculation formula of process close loop control:

- 0: Main + auxiliary 1: Main - auxiliary 2: Auxiliary -50% 3: Main+ auxiliary-50%
4: Maximum 5: Minimum

Note:

- Under analog feedback close loop control, the analog main reference, analog auxiliary reference, analog main feedback and analog auxiliary feedback cannot be set to the same channel.
- When the process close loop analog feedback mode is DI, the pulse will be translated into analog (0~10V) as feedback: Analog = pulse/maximum pulse input frequency P5.10×10V.

P1.08	Process open loop and close loop calculation formula for composite control	0 ~ 1(0)
-------	--	----------

This parameter function is similar to parameter P1.01. The process open loop composite reference f_{com} in this function definition can be treated as main reference, the frequency output of closed loop PID regulation f_{PID} can be treated as auxiliary reference, and f_{FIN} can be treated as composite reference.

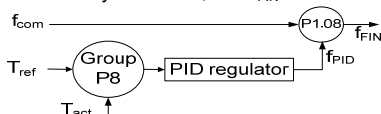

Figure6-10 Open loop and closed loop composite operation reference

0: $F_{FIN} = f_{com} + f_{PID}$, add the process closed loop result f_{PID} to the process open loop reference f_{com}

1: $F_{FIN} = f_{com} - f_{PID}$, subtract the process closed loop result f_{PID} from the process open loop reference f_{com}

Note:

In the case of analog feedback closed loop, refer to description of P1.02 to P1.04 for the reference mode T_{ref} , refer to the description of P1.05 to P1.07 for the feedback mode T_{act} .

6.3 Key and Display Parameters (Group P2)

P2.00

Operation panel key-locking function selection

0 ~ 3(0)

This parameter is used to realize the keys locking function of operation panel, so as to avoid mis-operation.

- 0: The keys on the operation panel are not locked, and all the keys are enabled.
- 1: The keys on the operation panel are locked, and all the keys are disabled.
- 2: All the keys are locked except MULTI key.
- 3: All the keys are locked except RUN and STOP/RST keys.

Note:

For the effective methods of key locking, refer to 4.6 description in Chapter 4.

P2.01

Multi-function M key function selection

0 ~ 8(1)

The multi-function key on the operation panel can be set as the following functions:

- 0: No function.
- 1: Jog function: For the jog frequency and jog acceleration/deceleration time, refer to P3.11~P3.13.
- 2: Emergency stop 1: The motor will be stopped with the shortest deceleration time.
- 3: Emergency stop 2: The motor will coast to stop.
- 4: Circular switchover of run command channel (operation panel→terminal →communication). The MON status LED on the operation panel will indicate the corresponding status. It is effective only when the PRG key is pressed within 5 seconds, otherwise, the switched will be canceled, and the MON LED will restore to the former state.
- 5: Circular switchover of fast menu mode and basic menu mode.
- 6: Circular switchover of non-factory setting menu mode and basic menu mode.
- 7: Circular switchover of last changed 10 parameters menu mode and basic menu mode.
- 8: Circular switchover of all the parameters mode (basic menu mode→fast menu mode→non-factory setting menu mode→last changed 10 parameters menu mode), refer to description of P0.02.

P2.02

Display parameter selection in running status

0000 ~ FFFF (1CB0)

Up to 4 parameters can be set and displayed in running status, and viewed circularly by pressing >> key.

P2.02 Display parameter selection in running status		
Ones place	0: Reference frequency (Hz)	1: Bus voltage (V)
	2: AI1 (V)	3: AI2 (V)
	4: AI3 (V)	5: DI (%)
	6: External counts	7: Motor rotation speed (rpm)
	8: Close loop reference (%)	9: Close loop feedback (%)
	A: Reserved	B: Running frequency (Hz)
	C: Output current (A)	D: Output torque (%)
	E: Output power (kW)	F: Output voltage (V)
Tens place	Same as above	
Hundreds place	Same as above	
Thousands place	Same as above	

P2.03

Display parameter selection in stop status

0000 ~ FFFF (3210)

Up to 4 parameters can be set and displayed in stop status, and viewed circularly by pressing >> key.

P2.02 Display parameter selection in stop status		
Ones place	0: Reference frequency (Hz)	1: Bus voltage (V)
	2: AI1 (V)	3: AI2 (V)
	4: AI3 (V)	5: DI (%)
	6: External counts	7: Motor rotation speed (rpm)
	8: Close loop reference (%)	9: Close loop feedback (%)
	A: Reserved	B: Reserved
	C: Reserved	D: Reserved
	E: Reserved	F: Reserved
Tens place	Same as above	
Hundreds place	Same as above	
Thousands place	Same as above	

P2.04

Display parameter benchmark in running status

0 ~ F (0)

P2.05

Display parameter coefficient in running status

0.0 ~ 1000.0% (0.0%)

If the parameter is to be displayed has proportion relation with a physical value in the operation display parameter defined by P2.02, P2.04 can be used to designate the physical value as the display benchmark, and P2.05 can be used to set the coefficient of the display benchmark.

When a parameter is to be displayed (i.e. P2.05≠0), the physical value will be automatically added into the display parameter in running status and can be viewed by pressing >> key. In this situation, there will be 5 parameters are displayed. The unit indicator light for the newly added parameter are LED A and LED V.

P2.06

Display parameter benchmark in stop status

0 ~ F (0)

P2.07

Display parameter coefficient in stop status

0.0 ~ 1000.0% (0.0%)

If the parameter is to be displayed has proportion relation with a physical value in the stop display parameter defined by P2.03, P2.06 can be used to designate the physical value as the display benchmark, and P2.07 can be used to set the coefficient of the display benchmark.

When a parameter is to be displayed (i.e. P2.07≠0), the physical value will be automatically added into the display parameter in stop status and can be viewed by pressing >> key. In this situation, there will be 5 parameters are displayed. The unit indicator light for the newly added parameter are LED A and LED V.

6.4 Start/stop Parameters (Group P3)

P3.00	Start mode	0 ~ 2(0)
-------	------------	----------

This parameter is used to set the start mode; start mode should be selected according to the actual situation.

- 0: Start to run from the start frequency P3.03 and accelerates to the setting frequency after the start frequency holding time P3.04. If the motor is free rotating when start the run command, the motor will be automatically decelerated to low speed before the acceleration.
- 1: DC current is injected first to perform DC magnetizing and DC braking on the motor. The current and active time for the DC injection are set by P3.01 and P3.02. After the DC injection, start to run from the start frequency P3.03 and accelerates to the setting frequency after the start frequency holding time P3.04.
- 2: Flying start, the inverter will automatically identify the speed of the motor and directly start from the identified frequency. The current and voltage are smooth without any impact during the start.

Note:

During the DC current is injected, “-dc-” is displayed on the operation panel.

P3.01	DC injection current	0.0 ~ 120.0 % (0.0%)
P3.02	DC injection active time	0.0 ~ 30.0 s (0.0s)

The parameter P3.01 is used to set the current of the DC injection, indicated in a percentage of the rated current of the inverter. The setting range is 0.0~120.0% for constant torque series product and 0.0~90.0% for variable torque series product.

The parameter P3.02 is used to set the DC injection active time.

P3.03	Start frequency	0.00 ~ 60.00Hz (0.50Hz)
P3.04	Start frequency holding time	0.0 ~ 3600.0 s (0.0s)

The inverter start to run from the start frequency P3.03 and accelerates according to acceleration time after the start frequency holding time P3.04.

Note:

For the heavy load start applications, it will facilitate the start if the start frequency and holding time are properly set.

P3.05	Stop mode	0 ~ 2(0)
-------	-----------	----------

Stop mode should be selected according to the actual situation.

- 0: Decelerate to stop. Decelerate to stop according to the deceleration time.
- 1: Coast to stop. Cutting off the motor power and the motor coast to stop.
- 2: Decelerate to stop+ DC braking. First, decelerate to stop according to deceleration time, when the running frequency is lower than DC braking start frequency P3.06, inject the DC braking current setting by P3.07, and the DC braking active time is determined by P3.08.

Note:

During the DC braking, “-dc-” is displayed on the operation panel.

P3.06	DC braking start frequency	0.00 ~ 300.00 Hz (0.00Hz)
P3.07	DC braking current	0.0 ~ 120.0 % (0.0%)
P3.08	DC braking active time	0.0 ~ 30.0 s (0.0s)

P3.06 is used to set the DC braking start frequency during stopping.

P3.07 is used to set the DC braking current value. This value is presented as the percentage of inverter rated current. It ranges from 0.0 ~ 90.0% to in variable torque series.

P3.08 is used to set the active time of the DC braking current.

P3.09	RUN reverse selection	0 ~ 1(0)
-------	-----------------------	----------

For some production equipment, reverse running may cause equipment damage. This function can be used to prevent reverse running.

When the motor running direction is opposite to the required direction of the equipment, the wire connection of any two terminals at the inverter output to motor can be interchanged so that the run forward direction of the equipment is consistent with the run forward direction defined by the inverter.

P3.10	Forward/reverse switch-over dead zone time	0.0 ~ 3600.0 s (0.0s)
-------	--	-----------------------

This parameter is used to realize the waiting time for the zero crossing of rotation speed when the inverter switches from forward running to reverse running (or from reverse running to forward running).

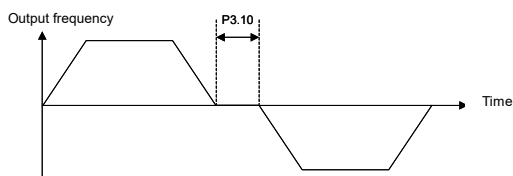

Figure6-11 Forward/reverse dead zone time

P3.11	Jog frequency	0.10 ~ 50.00 Hz (5.00Hz)
P3.12	Jog acceleration time	0.1 ~ 60.0 s (20.0s)
P3.13	Jog deceleration time	0.1 ~ 60.0 s (20.0s)

P3.11 is the frequency set for jog operation.

Jog acceleration time P3.12: The time from zero to maximum frequency (P0.11).

Jog deceleration time P3.13: The time from maximum frequency (P0.11) to zero.

When the inverter is in standby status, it can adopt jog operation. The jog operation command may come from the operation panel, multi-function terminal or host computer.

Note:

The jog function is disabled under torque control.

6.5 Multi-step Parameters (Group P4)

P4.00	V/F curve selection	0 ~ 6(0)
P4.01	Multi-point V/F frequency F0	0.00 ~ 300.00 Hz (1.00Hz)
P4.02	Multi-point V/F voltage V0	0.0 ~ 100.0 % (3.0%)
P4.03	Multi-point V/F frequency F1	0.00 ~ 300.00 Hz (10.00Hz)
P4.04	Multi-point V/F voltage V1	0.0 ~ 100.0 % (20.0%)
P4.05	Multi-point V/F frequency F2	0.00 ~ 300.00 Hz (25.00Hz)
P4.06	Multi-point V/F voltage V2	0.0 ~ 100.0 % (50.0%)
P4.07	Multi-point V/F frequency F3	0.00 ~ 300.00 Hz (50.00Hz)
P4.08	Multi-point V/F voltage V3	0.0 ~ 100.0 % (100.0%)

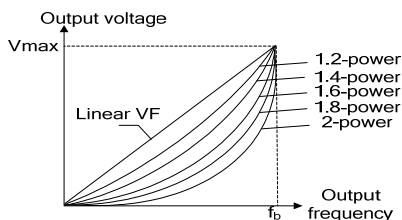

Figure 6-12 V/F curve

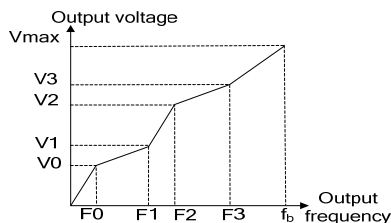

Figure6-13 Multi-point V/F curve

P4.00 is used to set the V/F curve selection.

0: Linear VF, Applicable to the constant torque load situation.

1: Multi-point VF curve setting by user, applicable to sectional constant torque load.

$F0 < F1 < F2 < F3 < f_b$ f_b is the motor basic frequency P0.15

$V0 \leq V1 \leq V2 \leq V3 \leq 100\%$ $V0, V1, V2, V3$ are the percentage of maximum output voltage P0.12

2~6: Applicable to the variable torque loads such as fan and pump. When P4.00 is set to 2~6, it corresponds to 1.2-power, 1.4-power, 1.6-power, 1.8-power and 2-power. The 2-power curve is for water supply and the 1.2-power to 1.8-power curves are for other liquid media loads. Proper curve can be selected according to the actual situation.

P4.00=2~6 is valid in E5-A, E5-H-4T**G-63 series.

P4.00=2~6 is invalid in E5-H series, if power curve is needed, use multi-point V/F curve instead.

For settings, refer to the following table.

Power curve	P4.01	P4.02	P4.03	P4.04	P4.05	P4.06	P4.07	P4.08
1.2-power	1.00	3.0	10.00	16.0	25.00	44.0	40.00	76.0
1.4-power	1.00	3.0	10.00	14.0	25.00	39.0	40.00	73.0
1.6-power	1.00	3.0	10.00	13.0	25.00	35.0	40.00	70.0
1.8-power	1.00	3.0	10.00	12.0	25.00	31.0	40.00	67.0
2-power	1.00	3.0	10.00	11.0	25.00	28.0	40.00	64.0

P4.09	Acceleration time 1	0.1 ~ 3600.0 s (20.0s)
P4.10	Deceleration time 1	0.1 ~ 3600.0 s (20.0s)
P4.11	Acceleration time 2	0.1 ~ 3600.0 s (20.0s)
P4.12	Deceleration time 2	0.1 ~ 3600.0 s (20.0s)
P4.13	Acceleration time 3	0.1 ~ 3600.0 s (20.0s)
P4.14	Deceleration time 3	0.1 ~ 3600.0 s (20.0s)

In addition to the acceleration time 0 (P0.08) and deceleration time 0 (P0.09), three groups of acceleration/deceleration time can be defined. Acceleration/deceleration time can be determined by the combinations of multi-function input terminal Xi (function is set to: "13", "14"). The meaning of the acceleration/deceleration time 1~3 is the same as P0.08 and P0.09.

The following table shows the acceleration/deceleration time combinations:

Acceleration/ deceleration time terminal 2	Acceleration/ deceleration time terminal 1	Acceleration time	Deceleration time
OFF	OFF	P0.08	P0.09
OFF	ON	P4.09	P4.10
ON	OFF	P4.11	P4.12
ON	ON	P4.13	P4.14

P4.15	Multi-step digital voltage reference 1	0.00 ~ 10.00 V (1.00V)
P4.16	Multi-step digital voltage reference 2	0.00 ~ 10.00 V (2.00V)
P4.17	Multi-step digital voltage reference 3	0.00 ~ 10.00 V (3.00V)
P4.18	Multi-step digital voltage reference 4	0.00 ~ 10.00 V (5.00V)
P4.19	Multi-step digital voltage reference 5	0.00 ~ 10.00 V (6.00V)
P4.20	Multi-step digital voltage reference 6	0.00 ~ 10.00 V (8.00V)
P4.21	Multi-step digital voltage reference 7	0.00 ~ 10.00 V (10.00V)

Multi-step digital voltage reference can be used as the process open loop frequency reference or analog feedback close loop digital voltage reference. Different digital voltage reference is determined by the combinations of multi-function input terminal Xi (function is set to "6", "7", "8").

Multi- step digital voltage input terminal 3	Multi- step digital voltage input terminal 2	Multi- step digital voltage input terminal 1	Process open loop frequency reference	Process close loop digital voltage reference
OFF	OFF	OFF	P0.05	P8.00
OFF	OFF	ON	P4.15	P4.15
OFF	ON	OFF	P4.16	P4.16
OFF	ON	ON	P4.17	P4.17
ON	OFF	OFF	P4.18	P4.18
ON	OFF	ON	P4.19	P4.19
ON	ON	OFF	P4.20	P4.20
ON	ON	ON	P4.21	P4.21

P4.22	Multi-step frequency reference 1	0.00 ~ 300.00 Hz (5.00Hz)
P4.23	Multi-step frequency reference 2	0.00 ~ 300.00 Hz (8.00Hz)
P4.24	Multi-step frequency reference 3	0.00 ~ 300.00 Hz (10.00Hz)
P4.25	Multi-step frequency reference 4	0.00 ~ 300.00 Hz (15.00Hz)
P4.26	Multi-step frequency reference 5	0.00 ~ 300.00 Hz (18.00Hz)
P4.27	Multi-step frequency reference 6	0.00 ~ 300.00 Hz (20.00Hz)
P4.28	Multi-step frequency reference 7	0.00 ~ 300.00 Hz (25.00Hz)
P4.29	Multi-step frequency reference 8	0.00 ~ 300.00 Hz (28.00Hz)
P4.30	Multi-step frequency reference 9	0.00 ~ 300.00 Hz (30.00Hz)
P4.31	Multi-step frequency reference 10	0.00 ~ 300.00 Hz (35.00Hz)
P4.32	Multi-step frequency reference 11	0.00 ~ 300.00 Hz (38.00Hz)
P4.33	Multi-step frequency reference 12	0.00 ~ 300.00 Hz (40.00Hz)
P4.34	Multi-step frequency reference 13	0.00 ~ 300.00 Hz (45.00Hz)
P4.35	Multi-step frequency reference 14	0.00 ~ 300.00 Hz (48.00Hz)
P4.36	Multi-step frequency reference 15	0.00 ~ 300.00 Hz (50.00Hz)

It can be used as process open loop frequency reference. Different multi-step frequency reference is determined by the combinations of multi-function input terminal Xi (function is set to "9", "10", "11", "12").

Multi-step frequency terminal 4	Multi-step frequency terminal 3	Multi-step frequency terminal 2	Multi-step frequency terminal 1	Frequency
OFF	OFF	OFF	OFF	P0.05
OFF	OFF	OFF	ON	P4.22
OFF	OFF	ON	OFF	P4.23
OFF	OFF	ON	ON	P4.24
OFF	ON	OFF	OFF	P4.25
OFF	ON	OFF	ON	P4.26
OFF	ON	ON	OFF	P4.27
OFF	ON	ON	ON	P4.28
ON	OFF	OFF	OFF	P4.29
ON	OFF	OFF	ON	P4.30
ON	OFF	ON	OFF	P4.31
ON	OFF	ON	ON	P4.32
ON	ON	OFF	OFF	P4.33
ON	ON	OFF	ON	P4.34
ON	ON	ON	OFF	P4.35
ON	ON	ON	ON	P4.36

Note:

If multi-step digital voltage reference and multi-step frequency reference are effective simultaneously, multi-step frequency reference has a high priority.

6.6 Multi-function Input Parameters (Group P5)

P5.00	Digital input terminal X1 function selection	00 ~ 99(02)
P5.01	Digital input terminal X2 function selection	00 ~ 99(03)
P5.02	Digital input terminal X3 function selection	00 ~ 99(99)
P5.03	Digital input terminal X4 function selection	00 ~ 99(99)
P5.04	Digital input terminal X5 function selection	00 ~ 99(99)
P5.05	Digital input terminal X6 function selection	00 ~ 99(99)
P5.06	Digital input terminal X7/DI function selection	00 ~ 99(99)

Relevant terms explanation:

- Terminal Xi: Refers to any of terminal X1, X2, X3, X4, X5, X6 or X7, also called terminal X.
There are seven programmable digital input terminal on the control board for "E5-H-4T**G-34", "E5-H-4T**G-63" and E5-A series.
There are four programmable digital input terminal on the control board for "E5-H-4T**G" series.
- Terminal Yi: Refers to terminal Y1, Y2 or relay also called terminal Y.
There are two programmable open collector output terminal and one relay output terminal on the control board for "E5-H-4T**G-34", "E5-H-4T**G-63" and E5-A series.
There are one programmable open collector output terminal and one relay output terminal on the control board for "E5-H-4T**G" series.
- Terminal function is enabled(ON): Means that digital input terminal Xi has set the function under description. And the terminal is closed if P7.25 is set to factory setting (positive logic); or the terminal is open when the P7.25 is set to non factory setting (negative logic).
- Terminal function is disabled (OFF): Means that terminal Xi has not set the function under description; or it has set the function, but the terminal is open when P7.25 is set to factory setting (positive logic); or the terminal is closed when the P7.25 is set to non factory setting (negative logic).
- The factory setting of terminal X1 function is FWD (P5.00=02), terminal X2 function is REV (P5.01=03), terminal X3 to X7 are no function (P5.02 ~ P5.06 are set to 99).

The following table lists the multi-function digital input terminal functions:

Setting value	Function	Setting value	Function
00	Jog forward	27	Stop via terminal with DC braking 2
01	Jog reverse	28	Counter input
02	Forward (FWD)	29	Counter reset
03	Reverse (REV)	30~31	Reserved
04	Three-wire control	32	Force to wake-up
05	Pulse frequency DI input (X7/DI)	33~46	Reserved
06	Multi-step digital voltage terminal 1	47	Single phase pulse input for closed loop control
07	Multi-step digital voltage terminal 2	48	Run command is changed to operation panel
08	Multi-step digital voltage terminal 3	49	Run command is changed to terminal
09	Multi-step frequency terminal 1	50	Run command is changed to communication
10	Multi-step frequency terminal 2	51	Changeover between process close loop control and open loop control
11	Multi-step frequency terminal 3	52	Main frequency reference is changed to digital
12	Multi-step frequency terminal 4	53	Reserved
13	Acceleration/deceleration time terminal 1	54	Main frequency reference is changed to AI1
14	Acceleration/deceleration time terminal 2	55	Main frequency reference is changed to AI2
15	Clear UP/DN regulation value	56	Main frequency reference is changed to AI3
16	Terminal UP (frequency increase)	57	Main frequency reference is changed to DI
17	Terminal DN (frequency decrease)	58	Auxiliary frequency reference is changed to NONE
18	Acceleration and deceleration is prohibited	59	Reserved
19	External fault input	60	Auxiliary frequency reference is changed to AI1
20	Fault reset (RESET)	61	Auxiliary frequency reference is changed to AI2
21	Run pause	62	Auxiliary frequency reference is changed to AI3
22	Run is prohibited	63	Auxiliary frequency reference is changed to DI
23	Stop via terminal	64~66	Reserved
24	Coast to stop via terminal	67	Process closed loop output forced to 0
25	Stop via terminal with DC braking 1	68	PID positive logic or negative logic selection
26	Emergency stop 1 (fastest stop)	69~98	Reserved

00: Terminal jog forward input

01: Terminal jog reverse input

02: Terminal run forward input (FWD)

03: Terminal run reverse input (REV)

The functions of above items 0 to 3 are only enabled when the run command reference channel is terminal (P0.06=1). Terminal run command and jog run command should be interlocked.

04: Three-wire control

It is only enabled in the terminal run command reference mode (P0.06=1). Refer to parameter P5.11.

05: Pulse frequency DI input (only available for X7/DI terminal)

When the pulse frequency DI input acts as the reference (e.g. P0.04=4 or P1.02=4), this function must be selected for the X7/DI terminal.

06: Multi-step digital voltage terminal 1

07: Multi-step digital voltage terminal 2

08: Multi-step digital voltage terminal 3

Refer to the parameter descriptions of P4.15 ~ P4.21.

09: Multi-step frequency terminal 1

10: Multi-step frequency terminal 2

11: Multi-step frequency terminal 3

12: Multi-step frequency terminal 4

Refer to the parameter descriptions of P4.22 ~ P4.36.

13: Acceleration/deceleration time terminal 1

14: Acceleration/deceleration time terminal 2

Refer to the parameter descriptions of P4.09 ~ P4.14.

15: Clear UP/DN regulation value

It is used to clear the change values of the reference frequency regulated by the operation panel \wedge / \vee and terminal UP/DN. And when this terminal function is enabled, the operation panel \wedge / \vee and terminal UP/DN are disabled.

16: Terminal UP (Frequency increase command)

17: Terminal DN (Frequency decrease command)

The two terminals are used to modify the setup frequency. When the terminal contact is ON, the frequency will be increased/decreased.

18: Acceleration and deceleration is prohibited

If this terminal function is enabled, the current frequency output will be maintain except stop command.

19: External fault input

When this terminal function is enabled, inverter will stop running and display "E.oUt" fault.

20: Fault reset (RESET)

This terminal is used to fault reset, which can also be done with the STOP/RST key on the operation panel and the host computer command.

21: Run pause

In running status, if this terminal function is enabled, run status will be paused and the output frequency become 0 immediately, the motor will coast to stop. But the inverter is still in running status and the RUN indicator is ON. The inverter will continue to run from 0Hz after the terminal change from ON to OFF (falling edge).

22: Run is prohibited

Once this terminal function is enable, the motor will coast to stop immediately. The inverter is allowed to start only when this terminal function is disabled.

23: Stop via terminal

When the inverter is in the running status, if this terminal change from OFF to ON (rising edge, terminal function from disabled to enabled), the motor will deceleration to stop. But it is important to note that if in stop status and this terminal keeps ON, the motor will run if receive run command.

24: Coast to stop via terminal

When the inverter is in the running status, if this terminal change from OFF to ON (rising edge, terminal function from disabled to enabled), the motor will coast to stop immediately. But it is important to note that if in stop status and this terminal keeps ON, the motor will run if receive run command.

25: Stop via terminal with DC braking 1

When the inverter is in the running status, if this terminal change from OFF to ON (rising edge, terminal function from disabled to enabled), the motor will deceleration to stop. When the running frequency is lower than the DC braking start frequency (P3.06), the inverter will start DC braking. The braking current is set by P3.07, and the braking time is the longer one between the terminal ON time and the DC braking active time (P3.08).

26: Emergency stop 1 (fastest stop)

When the inverter is in the running status, if this terminal change from OFF to ON (rising edge, terminal function from disabled to enabled), the motor will stop in the fastest way. The inverter will automatically determine the deceleration time according to the load and stop as fast as possible. But it is important to note that if in stop status and this terminal keeps ON, the motor will run if receive run command.

27: Stop via terminal with DC braking2

If this terminal keeps in ON status, if the motor receive a stop command and the stop mode is deceleration to stop or deceleration to stop + DC braking (P3.05=0 or P3.05=2), when the running frequency is lower than the DC braking frequency (P3.06), the inverter will start DC braking. The braking current is set by P3.07, and the braking time is the longer one between the terminal ON time and the DC braking active time (P3.08).

28: Counter input

This function is used to count pulses and the maximum input frequency is 200Hz, such as work counting and other low speed pulse signals. For details, refer to P5.12 and P5.13.

29: Counter reset

It is used to reset the counter.

30 to 31: Reserved**32: Force to wake-up**

If this terminal function is enabled, the inverter will be forced to wake-up.

47: Single-phase pulse input for process close loop control

When the pulse frequency DI input acts as feedback (P0.03=2), it must set the X7/DI terminal function to single-phase pulse input (P5.06=47). Refer to P8.01 and P0.03 for descriptions.

48: Run command is changed to operation panel

49: Run command is changed to terminal

50: Run command is changed to communication

The above three functions are set to change the run command channel. When the terminal is switched from OFF status to ON status, the rising edge trigger is enabled.

51: Changeover between process close loop control and open loop control

The terminal is used to change the process open loop operation and process close loop operation .

If P0.03=0, this terminal function is disabled, control mode is process open loop.

This terminal function is enabled, control mode is process close loop.

If P0.03=1/2, this terminal function is disabled, control mode is process close loop.

This terminal function is enabled, control mode is process open loop.

52: Main frequency reference is changed to digital setting

54: Main frequency reference is changed to AI1

55: Main frequency reference is changed to AI2

56: Main frequency reference is changed to AI3

57: Main frequency reference is changed to DI

The above five functions are used to change main frequency reference channel. When the terminal is switched from OFF status to ON status, the edge trigger is enabled. When this function is enabled, it will be changed from the current main frequency reference channel to the main frequency reference channel corresponding to the terminal function.

58: Auxiliary frequency reference is changed to NONE

60: Auxiliary frequency reference is changed to AI1

61: Auxiliary frequency reference is changed to AI2

62: Auxiliary frequency reference is changed to AI3

63: Auxiliary frequency reference is changed to DI

The above five functions are set to change for auxiliary frequency channel. When the terminal is switched from OFF status to ON status, the edge trigger is enabled. When this terminal is enabled, it will be changed from the current auxiliary frequency reference channel to the auxiliary frequency reference channel corresponding to this terminal function.

59, 64 to 66: Reserved

67: Process closed loop output is forced to 0

In process closed loop control mode or composite control mode, when this terminal function is enabled, the output frequency of process closed loop regulation (PID) is forced to 0.

68: PID positive logic or negative logic selection

PID is positive logic by default. If negative logic is required (when feedback value is greater than reference value and the frequency needed increase). PID negative logic should be enable through setting P8.09=1 or multi-function terminal function setting as 68.

P8.09=0, terminal is OFF: positive logic

P8.09=0, terminal is ON: negative logic

P8.09=1, terminal is ON: positive logic

P8.09=1, terminal is OFF: positive logic

69 to 98: Reserved

P5.07	X1 to X7 terminal filter time	0.000 ~ 1.000 s (0.100s)
-------	-------------------------------	--------------------------

This parameter is used to improve the anti-interference capability of the multi-function digital input terminal.

P5.08	X1 terminal delay time	0.0 ~ 999.9 s (0.0s)
P5.09	X2 terminal delay time	0.0 ~ 999.9 s (0.0s)

P5.08 and P5.09 are used to set X1 terminal delay time and X2 terminal delay time. This function is used to delay a certain time to respond after receive input terminal signal.

Note:

The signal can be identified only when the X1/X2 signal pulse width greater than X1/X2 terminal delay time. See the following figure, t_{w1} can be identified and t_{w2} will be ignored.

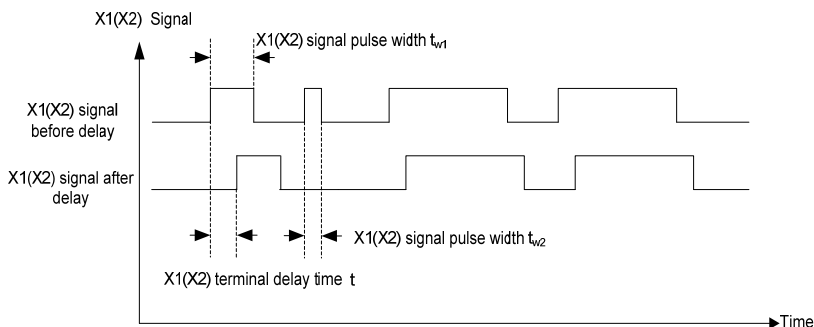

Figure6-14 X1/X2 terminal delay time

P5.10	Maximum input pulse frequency	0.1 ~ 50.0 kHz (10.0 kHz)
-------	-------------------------------	---------------------------

When the pulse input of the multi-function input terminal X7/DI acts as open loop frequency reference or analog feedback close loop reference (e.g. P0.04=4 or P1.02=4), the maximum input pulse frequency determined via this parameter.

When the pulse input acts as open loop frequency reference, maximum input pulse frequency P5.10 corresponds to maximum output frequency P0.11, the current pulse input frequency f_P and open loop frequency reference f can be calculated as per the following formula:

$$f = f_P \times P0.11 / P5.10$$

When the pulse input acts as close loop frequency reference or feedback, maximum input pulse frequency P5.10 corresponds to maximum digital voltage reference 10V, the current pulse input frequency f_P and analog feedback close loop reference V_P can be calculated as per the following formula:

$$V_P = f_P \times 10V / P5.10$$

P5.11

Start/stop mode selection

0 ~ 3(0)

P5.11 is used to set the mode of controlling the start and stop of the inverter with FWD and REV terminals when run command reference mode is terminal.

0: Two wire control 1

1: Two wire control 2

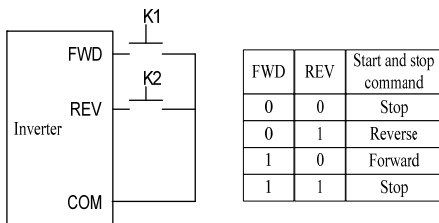

Figure6-15 Two wire control mode 1

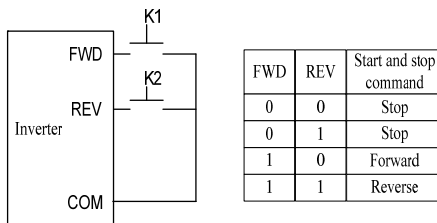

Figure6-16 Two wire control mode 2

2: Three wire control 1

When one of P5.00 to P5.06 (digital terminal function X1 to X7) is set to “4: Three-wire control” .

See the following figure, when K3 is ON, FWD and REV can be activated; when K3 is OFF, FWD and REV can not be activated.

The rising edge of FWD terminal means run forward command, while the rising edge of REV terminal means run reverse command.

3: Three wire control 2

When one of P5.00 to P5.06 (digital terminal function X1 to X7) is set to “4: Three-wire control” .

See the following figure, when K3 is ON, FWD and REV can be activated; when K3 is OFF, FWD and REV can not be activated.

The rising edge of FWD terminal means run command; REV terminal in OFF status means run forward command, REV terminal in ON status means run reverse command.

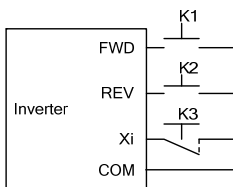

Figure6-17 Three-wire control mode 1

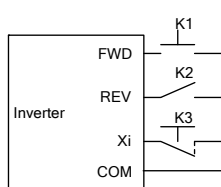

Figure6-18 Three-wire control mode 2

P5.12	Preset counting value setting	0000 ~ 9999(0000)
P5.13	Designated counting value setting	0000 ~ 9999(0000)

When the pulse signal counting of the terminal input complies with the preset condition, the terminal Yi will output corresponding instructions. The setting procedures are as follows:

1. Setting one of P5.00 to P5.06 (digital terminal function X1 to X7) to "28: Counter input", and setting P5.12 and P5.13, such as P5.12=4 and P5.13=8.
2. Setting one of P7.00 to P7.02 (Y1/Y2/relay output terminal function) to "10: Reach preset counting value", and the action sequence is shown as Out1 in the following figure. Effective level will be output when the counting value is between the values of P5.12 and P5.13.
3. Setting one of P7.00 to P7.02 (Y1/Y2/relay output terminal function) to "11: Reach designated counting value", and the action sequence is shown as Out2 in the following figure. Effective level will be output when the counting value reaches the value of P5.13 and maintain till the counting value changes.

Note:

- P5.12 cannot be set to a value of higher than P5.13, and the counter pulse signal frequency range is 0Hz to 200Hz. The voltage range is $24V \pm 20\%$.
- Setting one of P5.00 to P5.06 (digital terminal function X1 to X7) to "29: Counter reset", and reset the counting value when this terminal function is enabled.

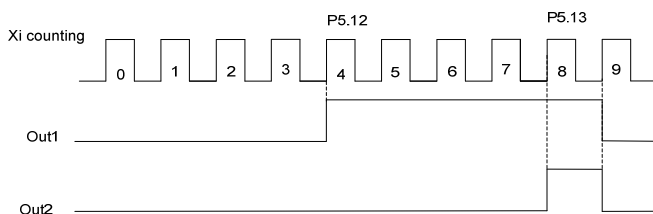

Figure6-19 Schematic diagram for the preset and designated counting value

6.7 Analog Reference Parameters (Group P6)

P6.00

AI1 to AI3 and DI input curve selection

0000 ~ 4444 (4444)

This function is used to define the analog input range and target range. Four curves are provided for users. Three of curves have a linear correspondence and one curve have four-point correspondence. The setting should according actual requirement.

P6.00 AI1 to AI3 and DI input curve selection	
Ones place	AI1 input curve selection: 0: Reference frequency determined by curve 1 (P6.01 ~ P6.04) 1: Reference frequency determined by curve 2 (P6.05 ~ P6.08) 2: Per unit value determined by curve 3 (P6.09 to P6.12) 3: Per unit value determined by curve 4 (P6.13 to P6.20) 4: NONE
Tens place	AI2 input curve selection: Same as above
Hundreds place	AI3 input curve selection: Same as above
Thousands place	DI input curve selection: Same as above

Curve 1 can be used to directly realize the corresponding relationship between the analog input value and the reference frequency.

Curve 2 and curve 1 are the same usage method.

Curve 3 and curve 4 can be used to convert the externally input analog value into internal per unit value. All the input analog functions are programmable setting by P6.21.

Note:

- AI1 ~ AI3 and DI values can be displayed through setting P2.02 or P2.03, DI displayed unit is %, the maximum input pulse frequency P5.10 corresponding to 100.0%.
- When analog curve "NONE" is selected, the maximum analog input or maximum pulse frequency input corresponding to the maximum output frequency P0.11 or 100.0% per unit value.

P6.01	Curve 1 input point A0	0.0 ~ 110.0 % (0.0%)
P6.02	Reference frequency f0 corresponding to curve 1 input point A0	0.00 ~ 300.00 Hz (0.00Hz)
P6.03	Curve 1 input point A1	0.0 ~ 110.0 % (100.0%)
P6.04	Reference frequency f1 corresponding to curve 1 input point A1	0.00 ~ 300.00 Hz (50.00Hz)
P6.05	Curve 2 input point A0	0.0 ~ 110.0 % (0.0%)
P6.06	Reference frequency f0 corresponding to curve 2 input point A0	0.00 ~ 300.00 Hz (0.00Hz)
P6.07	Curve 2 input point A1	0.0 ~ 110.0 % (100.0%)
P6.08	Reference frequency f1 corresponding to curve 2 input point A1	0.00 ~ 300.00 Hz (50.00Hz)

Since the using methods of curve 1 and curve 2 are identical, Curve 1 is described as an example here. Both curve 1 and curve 2 can be used as process open loop frequency reference, and the reference frequency can be determined by the analog values AI1, AI2, AI3 or DI pulse frequency. The relationship between analog value and setup frequency is as shown in the following figures.

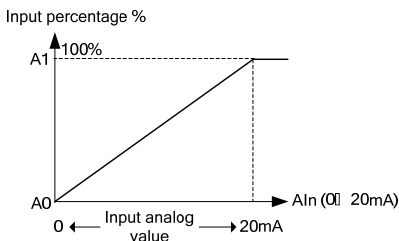
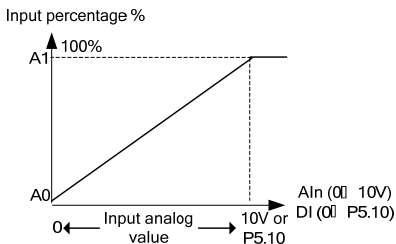

Figure6-20 Percentage of input analog (voltage/pulse) Figure6-21 Percentage of input analog (current)

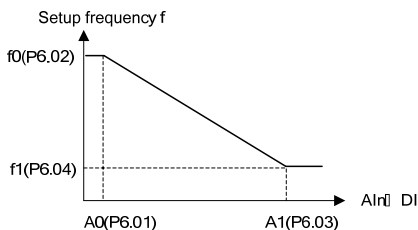
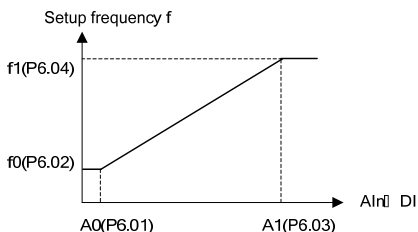

Figure6-22 Reference frequency curve (positive) Figure6-23 Reference frequency curve (negative)

e.g. AI2 input 4 ~ 20mA corresponding to 0 ~ 50Hz :

- 1) First, check the AI2 jumper if is switched to I side
- 2) Setting P6.00 tens place to 0, select curve 1
- 3) Setting P6.01=20.0
- 4) Fine tuning maybe required because of zero drift, for example setting P6.01=20.2, P6.03=99.8

P6.09	Curve 3 input point A0	0.0 ~ 110.0 % (0.0%)
P6.10	Per unit value B0 corresponding to curve 3 input point A0	0.0 ~ 110.0 % (0.0%)
P6.11	Curve 3 input point A1	0.0 ~ 110.0 % (100.0%)
P6.12	Per unit value B1 corresponding to curve 3 input point A1	0.0 ~ 110.0 % (100.0%)
P6.13	Curve 4 input point A0	0.0 ~ 110.0 % (0.0%)
P6.14	Per unit value B0 corresponding to curve 4 input point A0	0.0 ~ 110.0 % (0.0%)
P6.15	Curve 4 input point A1	0.0 ~ 110.0 % (25.0%)
P6.16	Per unit value B1 corresponding to curve 4 input point A1	0.0 ~ 110.0 % (25.0%)
P6.17	Curve 4 input point A2	0.0 ~ 110.0 % (50.0%)
P6.18	Per unit value B2 corresponding to curve 4 input point A2	0.0 ~ 110.0 % (50.0%)
P6.19	Curve 4 input point A3	0.0 ~ 110.0 % (100.0%)
P6.20	Per unit value B3 corresponding to curve 4 input point A3	0.0 ~ 110.0 % (100.0%)

Curve 3 have a linear correspondence and curve 4 have four-point correspondence.

The input analog characteristics curve as shown in the following figure. Curve 4 is described as an example here.

Curves 3 and 4 convert the externally input analog into the internal value. All the AI and DI inputs will be converted to percentage. The maximum analog input or maximum pulse frequency input corresponding 100.0% per unit value.

The function of per unit value is determined by the analog channel function selection P6.21.

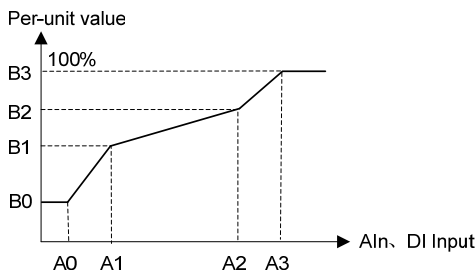

Figure 6-24 Input analog characteristics curve

P6.21	AI1~AI3、DI analog channel function selection	0000 ~ 6666(0000)
-------	--	-------------------

P6.21 is used to select functions of AI1, AI2, AI3 and DI input. The using methods of AI1, AI2, AI3 and DI are identical.

P6.21 AI1~AI3、DI analog channel function selection	
Ones place	AI1 function selection 0: Open loop frequency, close loop reference, close loop feedback 1~4: Reserved 5: Motor temperature feedback (overload protection sensor mode) 6: Reserved
Tens place	AI2 function selection, same as above
Hundreds place	AI3 function selection, same as above
Thousands place	DI function selection, same as above

0: Open loop frequency reference, analog close loop reference, close loop feedback.

For open loop frequency reference, refer to the parameter description of P0.04.

For analog close loop reference, refer to the parameter description of P1.02, P1.03.

For analog close loop feedback, refer to the parameter description of P1.05, P1.06.

5: Motor temperature feedback: It is used together with parameter P9.17 for motorthermal protection.

1 to 4, 6: Reserved

Note:

If the analog channel function is set a non-zero value, please make sure that different analog channels have different functions.

P6.22	AI1 filter time	0.000 ~1.000 s (0.004s)
P6.23	AI2 filter time	0.000 ~1.000 s (0.004s)
P6.24	AI3 filter time	0.000 ~1.000 s (0.004s)

The analog values input via AI1, AI2 and AI3 terminals usually have certain interference signals. It can amplify the setup value of AI filter time properly to improve the anti-interference capability.

P6.25	AI1 configured as multi-function digital input terminal	00 ~ 99 (99)
P6.26	AI2 configured as multi-function digital input terminal	00 ~ 99 (99)
P6.27	AI3 configured as multi-function digital input terminal	00 ~ 99 (99)

AI1, AI2 and AI3 can be configured as multi-function digital input terminal, when the parameter value are set to "99", the analog configured as analog input, else configured as multi-function digital input.

When AI1, AI2 and AI3 configured as multi-function digital input terminal, the terminal function is the same as X1 to X7. Refer to the parameter descriptions of P5.00 to P5.06.

Note:

If the analog input has been configured as multi-function digital input terminal, then the following limit values apply: $\leq 3V$ DC \rightarrow "OFF", means the terminal function is disabled.

$\geq 7V$ DC \rightarrow "ON", means the terminal function is enabled.

6.8 Multi-Function Output Parameters (Group P7)

P7.00	Y1 output function selection	00 ~ 47(00)
P7.01	Y2/DO output function selection	00 ~ 71(01)
P7.02	Relay output function selection	00 ~ 47(14)
P7.03	AO1 output function selection	48 ~ 71(48)
P7.04	AO2 output function selection	48 ~ 71(49)

Y1, relay terminals: multi-function digital output.

Y2/DO: multi-function digital output or high-speed pulse output (0 ~ 50kHz).

AO1 and AO2: multi-function analog output. 0 ~ 10V or 0 ~ 20mA can be selected by jumper.

The definition table of multi-function digital signal output is as follows:

Setting	Function	Setting	Function
0	Signal indicating that the inverter is running (RUN)	1	Running frequency arrival output(FAR)
2	Frequency level detection 1 output(FDT1)	3	Frequency level detection 2 output (FDT2)
4	Inverter or motor overload pre-alarm(OL)	5	Under voltage (LU)
6	Stop due to external fault input (EXT)	7	Frequency reach upper limit(FHL)
8	Frequency reach lower limit(FLL)	9	Frequency reach 0 Hz (still output at stop status)
10	Preset counting value reached	11	Designated counting value reached
12	Reserved	13	Ready for operation (RDY)
14	Fault output	15	Alarm output (only alarm but not stop)
16	Reserved	17	Accumulative running time reached
18	Continuous running time reached	19	Output X1
20	Output X2	21	Reserved
22	Zero current detection arrival (relative to motor)	23	Stop command (still output in stop status)
24	Run command direction instruction	25	Running status direction instruction
32	Sleep status indication	26~31, 33~47:	Reserved

00: Signal indicating that the inverter is running (RUN)

The signal is enabled when the inverter is running.

01: Running frequency arrival output (FAR)

When the deviation between the output frequency and the reference frequency is in the range of P7.19 (running frequency arrival detection level), the signal is enabled. Refer to P7.19 for details.

02: Frequency level detection 1 output (FDT1)

When the output frequency is higher than P7.20 setting, the signal is enabled. When the output frequency is less than P7.21 setting, the signal is disabled. Refer to P7.20 ~ P7.21 for details.

03: Frequency level detection 2 output (FDT2)

When the output frequency is higher than P7.22 setting, the signal is enabled. When the output frequency is less than P7.23 setting, the signal is disabled. Refer to P7.22 ~ P7.23 for details.

04: Inverter or motor overload pre-alarm(OL)

When the output current exceeds the PA.14 (overload pre-alarm detection level) setting and lasts longer than PA.15 setting (overload pre-alarm detection time), the signal is enabled. When the current is lower than PA.14 setting, the signal is disabled. Refer to PA.13 ~ PA.15 for details.

05: Under voltage (LU)

When the inverter bus voltage is lower than the under voltage action value, the signal is enabled.

06: Stop due to external fault input (EXT)

When the inverter is in the protection status due to external fault input (one of multi function digital input terminal function is set to "19: external fault input"), the signal is enabled, and E.oUt" appears on the operation panel.

07: Frequency reach upper limit (FHL)

When the inverter output frequency reaches frequency upper limit (P0.13), the signal is enabled.

08: Frequency reach lower limit (FLL)

When the inverter output frequency reaches frequency lower limit (P0.14), the signal is enabled.

09: Frequency reach 0 Hz (still output at stop status)

When the output frequency is 0 Hz, the signal is enabled.

10: Preset counting value reached**11: Designated counting value reached**

When the counting value from input terminal reached, the signal is enabled, Refer to P5.12 and P5.13 for details.

13: Ready for operation (RDY)

When the power-on-self-test of is normal after power on and "run is prohibited"(one of multi function digital input terminal function is set to "22: run is prohibited") function is disable, the signal is enabled.

14: Fault output

When a fault occurs, and the inverter is in stop status due to the fault, the signal is enabled.

15: Alarm output

When the inverter is in the alarm status due to fault but does not stop, the signal is enabled.

17: Accumulative running time reached

The signal is enabled when the accumulative running time reaches the setting, and the signal will be reset after completely power-off. For details refer to Pb.14.

18: Continuous running time reached

The signal is enabled when the continuous running time reaches the setting, and the signal will be reset in stop status. For details refer to Pb.13.

19: Output X1

The status of multi-function digital input terminal X1 is output via the terminal Y, when X1 is enabled, the signal is enabled.

20: Output X2

The status of multi-function digital input terminal X2 is output via the terminal Y, when X2 is enabled, the signal is enabled.

22: Zero current detection arrival

When the output current is lower than the zero current detection level, the signal is enabled. Refer to P7.18 for details.

23: Stop command

When the inverter is in the stop or standby status, the signal is enabled.

24: Run command direction instruction

This function is used to output run command direction, regardless motor rotating direction.

25: Running status direction instruction

This function is used to output run running direction of the motor.

32: Sleep status indication

When the inverter is in sleeping status, the signal is enabled.

12, 16, 21, 26 ~ 21, and 33 ~ 47: Reserved

The definition table of multi-function analog output and pulse output is as follows:

Setting	Output function	Definition of analog output range	Definition of pulse output range
48	Output running frequency	Max. frequency P0.11 corresponds to 10V/20mA	Max. frequency P0.11 corresponds to P7.10
49	Output reference frequency	Max. frequency P0.11 corresponds to 10V/20mA	Max. frequency P0.11 corresponds to P7.10
50	Output current	Two times rated current of inverter corresponds to 10V/20mA	Two times rated current of inverter corresponds to P7.10
51	Motor current	Two times rated current of motor corresponds to 10V/20mA	Two times rated current of motor corresponds to P7.10
52	Output torque	Two times rated torque of motor corresponds to 10V/20mA	Two times rated torque of motor corresponds to P7.10
53	Output voltage	Two times max.output voltage P0.12 corresponds to 10V/20mA	Two times max. output voltage P0.12 corresponds to P7.10
54	Bus voltage	1000V corresponds to 10V/20mA	1000V corresponds to P7.10
55	AI1	10V corresponds to 10V/20mA 20mA corresponds to 10V/10mA	10V corresponds to P7.10 20mA corresponds to 50% of P7.10
56	AI2	Same as AI1	Same as AI1
57	AI3	-10V ~ 10V corresponds to 0 ~ 10V/20mA	-10V ~ 10V corresponds to 0 ~ P7.10
58	DI	Max. input pulse frequency P5.10 corresponds to 10V/20mA	Max. input pulse frequency P5.10 corresponds to P7.10
59	Output power	2 times rated output power of motor corresponds to 10V/20mA	2 times rated output power of motor corresponds to P7.10
60	Host computer percentage	10000 corresponds to 10V/20mA	10000 corresponds to P7.10
61	Heat-sink temperature	0 to 100°C corresponds to 0 to 10V/20mA	100°C corresponds to P7.10
62	Output frequency 2	Max. frequency P0.11 corresponds to 10V/20mA	Max. frequency P0.11 corresponds to 10V/20mA
63~71	Reserved		

Note:

Output frequency indicates the inverter output frequency, Output frequency 2 indicates the frequency calculate by motor speed.

P7.05	AO1 gain	0.0 ~ 200.0 % (100.0%)
P7.06	AO1 bias	0.0 ~ 200.0 % (0.0%)
P7.07	AO2 gain	0.0 ~ 200.0 % (100.0%)
P7.08	AO2 bias	0.0 ~ 200.0 % (0.0%)
P7.09	Positive logic or negative logic selection for gain and bias	0000 ~ 1111(0000)

This function can be used to adjust the analog outputs. The adjusted analog value is the actual output of the AO terminal.

P7.09 is used to determine the positive polarities or negative polarities of the gain or bias.

P7.09 Positive or negative selection of gain and bias	
Ones place	AO1 gain 0: Positive 1: Negative
Tens place	AO1 bias 0: Positive 1: Negative
Hundreds place	AO2 gain 0: Positive 1: Negative
Thousands place	AO2 bias 0: Positive 1: Negative

The parameters P7.05-P7.09, will change the AO1 and AO2 output timely.

AO1 and AO2 are identical. Take AO1 as an example:

Setting P7.05 to 100.0% and P7.06 to 20.0%, namely, $K=1$ and $b=2V$, and the AO1 characteristics curve is as shown in the following figure.

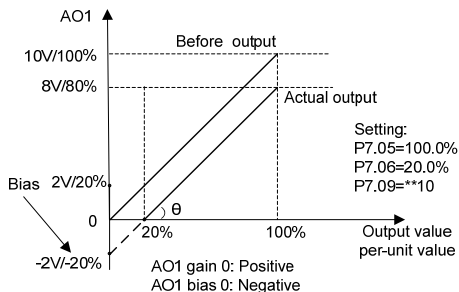
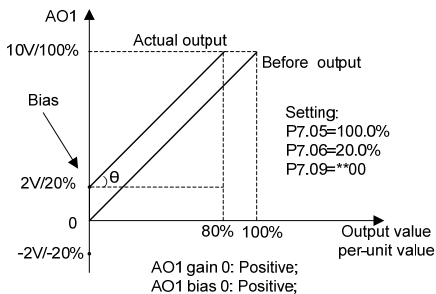

Figure6-25 AO1 Characteristics Curve $Kx+b$

Figure6-26 AO1 Characteristics Curve $Kx-b$

Setting P7.05 to 100.0% and P7.06 to 120.0%, namely, $K=1$ and $b=12V$, and the AO1 characteristics curve is as shown in the following figure.

Setting P7.05 to 100.0% and P7.06 to 80.0%, namely, $K=1$ and $b=8V$, and the AO1 characteristics curve is as shown in the following figure.

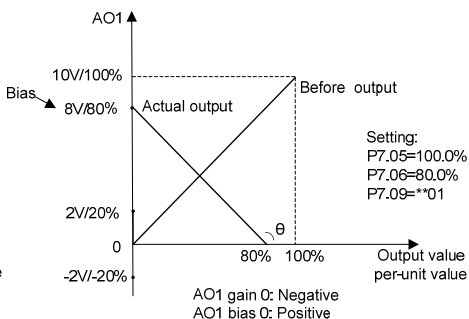
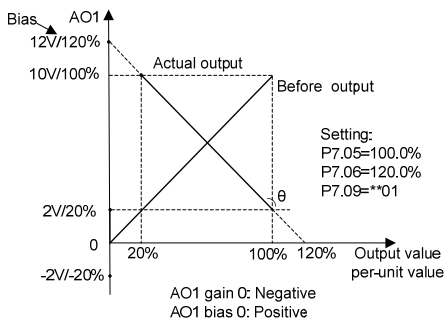

Figure6-27 AO1 Characteristics Curve-Kx+b

Figure6-28 AO1 Characteristics Curve-Kx+b

Note:

When the analog output both gain and bias are set to negative, the output will be limited to 0V.

P7.10	Y2/DO maximum output pulse frequency	0.1 ~ 50.0 kHz (10.0 kHz)
-------	--------------------------------------	---------------------------

This parameter determines the maximum frequency output by Y2/DO. Refer to P7.01 for details.

P7.11	Output signal type selection	000 ~ 101 (000)
-------	------------------------------	-----------------

This parameter determines Y1 and relay output signal type selection (level or pulse).

P7.11 Output signal type selection	
Ones place	Y1 terminal 0:Level signal 1:Pulse signal
Tens place	Reserved
Hundreds place	Relay terminal 0: Level signal 1:Pulse signal

P7.12	Y1 output function action delay time	0.0 ~ 999.9 s (0.0 s)
P7.13	Y1 output pulse width	0.0 ~ 999.9 s (0.0 s)
P7.14	Y2 output function action delay time	0.0 ~ 999.9 s (0.0 s)
P7.15	Reserved	0.0 ~ 999.9 s (0.0 s)
P7.16	Relay output function action delay time	0.0 ~ 999.9 s (0.0 s)
P7.17	Relay output pulse width	0.0 ~ 999.9 s (0.0 s)

The parameters of terminal action delay time both on the level output and the pulse output are enabled. The parameters of pulse width only for pulse signal.

Yi on behalf of Y1,Y2 and relay terminal, in order to keep the waveform consistent before delay and after delay, need to ensure that the output signal width > Yi terminal delay setting, if the output signal width < Yi terminal delay setting, the signal will be ignored.

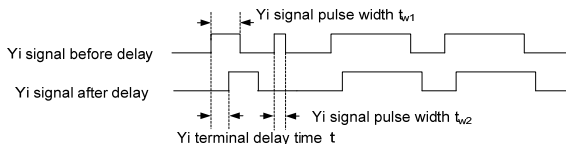

Figure 6-29 Delay of output terminal Yi

P7.18	Zero current detection level	0.0 ~ 50.0 % (0.0%)
-------	------------------------------	---------------------

This parameter is used to detect the load. If the output terminal is set to “22: Zero current detection arrival”, the output will be active if the output current is lower than the zero current detection level P7.18.

Note:

➤ This function parameter is percentage of rated current of the motor.

P7.19	Running frequency arrival detection level	0.00 ~ 300.00 Hz (2.50Hz)
-------	---	---------------------------

This parameter is used to detect the deviation between output frequency and reference frequency.

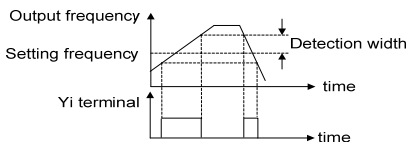

Figure6-30 Frequency arrival signal (FAR)

Once on of the output terminal function is set to “1: Running frequency arrival output”, the deviation between the output frequency and the reference frequency of is in the range of P7.19 setting, the output will be active, as shown in the figure. Yi represents Y1 / Y2 terminals or relay terminal.

P7.20	FDT1 level upper limit	0.00 ~ 300.00 Hz (50.00Hz)
P7.21	FDT1 level lower limit	0.00 ~ 300.00 Hz (49.00Hz)
P7.22	FDT2 level upper limit	0.00 ~ 300.00 Hz (25.00Hz)
P7.23	FDT2 level lower limit	0.00 ~ 300.00 Hz (24.00Hz)

These parameters are used for detecting whether the output frequency in within the setting range. If one of the output terminal function is set to “2: Frequency level detection 1 output” or “3: Frequency level detection 2 output”, the terminal output will be enabled if the output frequency is in the FDT range.

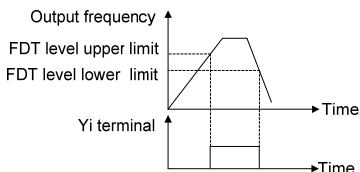

Figure6-31 Frequency level detection signal (FDT)

P7.24

Virtual terminal selection

000 ~ 101(000)

It controls the action of the multi-function input terminal or output terminal by the host computer.

P7.24 Virtual terminal effective selection	
Ones place	Multi-function input terminal Xi 0: The real terminal is enabled 1: The virtual terminal is enabled
Tens place	Reserved
Hundreds place	Y1, Y2 and relay terminals 0: The real terminal is enabled 1: The virtual terminal is enabled

When Xi terminal signal source is input as virtual terminal, whether the corresponding function of this terminal is effective depends on the control of the host computer and has no relationship with the real status of the current Xi terminal.

When Yi, Y2 and relay terminals are output as virtual terminals, the terminal output depend on the control of the host computer and have no relationship with the parameter setting.

P7.25

Input and output terminal active state selection

0000 ~ 1131(0000)

It defines the validity of the input and output status of the multi-function digital terminals.

P7.25 Input and output terminal active state selection	
Ones place	Multi-function digital input terminal Xi 0: Xi is active if current flowing through Xi, positive logic 1: Xi is active if no current flowing through Xi, negative logic
Tens place	Multi-function output terminal Yi 0: Y1 is active if current flowing through Y1, positive logic Y2 is active if current flowing through Y2, positive logic 1: Y1 is active if no current flowing through Y1, negative logic Y2 is active if current flowing through Y2, positive logic 2: Y1 is active if current flowing through Y1, positive logic Y2 is active if no current flowing through Y2, negative logic 3: Y1 is active if no current flowing through Y1, negative logic Y2 is active if no current flowing through Y2, negative logic
Hundreds place	Relay output terminal 0: Relay is active if in magnetizing status, positive logic 1: Relay is active if not in magnetizing status, negative logic
Thousands place	Reserved

When the digital input Xi terminal and COM terminal are short together, whether the input status is valid by judging whether there is current flowing through the terminals.

When the digital output Yi terminal acts as open collector output, whether the output status is valid by judging whether there is current flowing through the terminal.

Whether the relay output status is valid by judging whether the relay is in the magnetizing status.

6.9 Process PID Close Loop Parameters (Group P8)

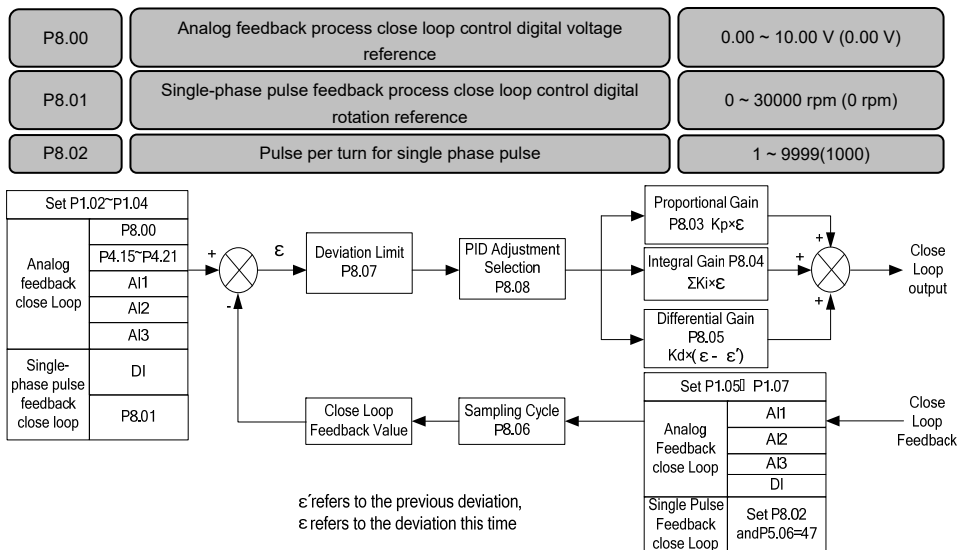

Figure 6-32 Schematic diagram for PID

The current control mode P0.03 should be determined before setting the close loop reference.

When the current control mode is analog feedback process close loop:

Close loop reference: Close loop reference determined by parameters P1.02 to P1.04.

if P1.02 is set to "0", close loop main reference value is set by P8.00.

If P1.02 is a non-zero value, close loop main reference channel is determined by P1.02 setting (analog AI1, AI2, AI3 or DI).

Close loop feedback: Determined by parameters P1.05 to P1.07.

When the current control mode is single-phase pulse feedback process close loop:

Close loop reference: Close loop reference value is set by P8.01.

Close loop feedback: When the single-phase pulse feedback process close loop is employed, it needs to use a pulse encoder and set the number of single-phase pulses per turn for the encoder according to the encoder nameplate (P8.02) so as to determine the close loop feedback value indicated by the single-phase pulse.

Note:

- In the single-phase pulse feedback process close loop control mode, the signal feedback by the single-phase pulse must be connected to X7/DI terminal and this terminal must be set to "47: Single phase pulse input for closed loop control".
- In the analog value feedback close loop control mode, if P1.02 is set to "0", multi-step digital voltage reference can be used to implement the multi-step reference for close loop. Refer to P4.15 ~ P4.21 for details.

P8.03	Proportional gain Kp	0.000 ~ 10.000(0.200)
P8.04	Integral gain Ki	0.000 ~ 10.000(0.500)
P8.05	Derivative gain Kd	0.000 ~ 10.000(0.000)

The larger the Kp value setting, the faster the response, but if the Kp value is too large, vibration may occur, and the deviation cannot be eliminated completely only by Kp.

It can use Ki to eliminate the residual deviation. The larger the Ki value setting, the faster the response to the deviation change, but if the Ki value is too large, vibration may occur.

If the system has frequent jump feedback, it needs to use Kd because Kd can respond to the deviation change between the system feedback and the reference quickly. The larger the Kd value setting, the faster the response is, but if the Kd value is too large, vibration may occur.

P8.06	Sampling cycle	0.001 ~ 30.000 s (0.002s)
-------	----------------	---------------------------

This function is used to set the sampling cycle of the feedback signal. The lower this parameter value is, the faster system response to the deviation between the reference and the feedback, but if the sampling cycle is too fast, the associate requirement for the system PID regulation will be higher, which may result in system vibration.

P8.07	PID deviation limit	0.0 ~ 20.0 % (5.0%)
-------	---------------------	---------------------

When this function determines the certain level of the deviation between the feedback signal and the reference signal, it will stop the internal PID regulation and maintain stable output. Only when the deviation between the feedback value and the reference value of the close loop exceeds the deviation limit of P8.07, the output will be updated. Setting the deviation limit needs to take the system control precision and stability into consideration.

P8.08	PID integral property	00 ~ 11(00)
-------	-----------------------	-------------

This parameter is used to set the integral property during the process close loop regulation.

P8.08 PID integral property	
Ones place	Integral mode: 0: Stop integral regulation after the running frequency reaches the upper or lower limit 1: Continue integral regulation after the running frequency reaches the upper or lower limit
Tens place	Output frequency 0: Must be consistent with preset direction 1: Can regulation to reverse to preset direction

If the output value of the close loop regulation reaches frequency upper limit or lower limit (P0.13 or P0.14), there are two actions for integration selection.

0: Stop integral regulation: the integral value remains unchanged. When there is change occurring to the deviation between the reference value and the feedback value, the integration value will follow that change trend.

1: Continue integral regulation: The integration value will immediately respond to the change between the reference value and the feedback value unless this value reaches the internal integral limit. When there is change occurring to the deviation between the reference value and the feedback value

changes, before the integral value catch up that change trend, it needs to take longer time to offset the effect brought by the continuous integral .

If the output value of the close loop regulation is inconsistent with the current setup running direction, the close loop output value has two actions for selection.

- 0: Must be consistent with preset direction: When the output value of the close loop regulation is inconsistent with the current setup running direction, the current output value will be forced to be 0 internally.
- 1: Can regulation to reverse to preset direction: When the output value of the close loop adjustment is inconsistent with the current preset running direction, the close loop regulation opposite to the current preset running direction will be executed.

P8.09

PID positive or negative function

0 ~ 1 (0)

PID is positive function by default. If negative function is required, such as if feedback value is greater than reference value and the frequency needed increase, this parameter should be used or the function of multi-function terminal function is set to "68".

P8.09=0, terminal function is disabled: positive

P8.09=1, terminal function is enabled: positive

P8.09=1, terminal function is disabled: negative

P8.09=0, terminal function is enabled: negative

P8.10

PID acceleration / deceleration time

0.0 ~ 6553.5 s (10.0s)

This parameter is used to set the PID regulation acceleration and deceleration time.

Note:

This parameter is only available for "E5-H-4T**G-63" non-standard series and E5-A series.

6.10 Motor Parameters (Group P9)

P9.00	Reserved	0 ~ 1(0)
P9.01	Motor poles	2 ~ 128(4)
P9.01	Motor rated speed	0 ~ 30000 rpm (1500rpm)
P9.03	Motor rated power	0.4 ~ 999.9 kW (Factory)
P9.04	Motor rated current	0.4 ~ 999.9 kW (Factory)

P9.01 ~ P9.04 are used to set the motor parameters according to motor nameplate.

P9.05	No-load current I0	0.1 ~ 999.9 A (Factory)
P9.06	Stator resistance R1	0.000 ~ 65.000 Ω (Factory)
P9.07	Stator leakage inductance L1	0.0 ~ 2000.0 mH (Factory)
P9.08	Rotor resistance R2	0.000 ~ 65.000 Ω (Factory)
P9.09	Mutual inductance L2	0.0 ~ 2000.0 mH (Factory)
P9.10	Magnetic flux saturation coefficient 1	0.00 ~ 100.00 % (Factory)
P9.11	Magnetic flux saturation coefficient 2	0.00 ~ 100.00 % (Factory)
P9.12	Magnetic flux saturation coefficient 3	0.00 ~ 100.00 % (Factory)
P9.13	Magnetic flux saturation coefficient 4	0.00 ~ 100.00 % (Factory)
P9.14	Magnetic flux saturation coefficient 5	0.00 ~ 100.00 % (Factory)
P9.15	Motor data identification	0 ~ 2(0)

It determines the key motor parameters affecting the running control through implementing the motor data identification. These motor parameters will be stored automatically after completion of motor data identification process till the parameter is changed or another motor data identification.

The process of motor data identification is described as follows:

- ◆ Input P9.00 to P9.04 properly in accordance with the motor nameplate, P0.15 motor rated frequency, P0.12 motor rated voltage, maximum output frequency P0.11 and the acceleration/deceleration time P0.08 and P0.09 properly.
- ◆ Select the motor data identification selection P9.15:
 - 1: Motor data identification at standstill. After setting P9.15 to 1, press **RUN** key on the operation panel to measure the motor parameters P9.06 ~ P9.08 automatically, and P9.15 will be restored to 0 automatically after completion.
 - 2: Complete motor data identification. After setting P9.15 to 2, press **RUN** key on the operation panel to measure the motor parameters P9.06 ~ P9.14 automatically, and P9.15 will be restored to 0 automatically after completion.

Note:

- If the motor can be disconnected from the load, complete motor data identification (P9.15=2) should be selected, or motor data identification at standstill should be selected only. Make sure that the motor

is in the standstill status when starting data identification. If there is over current or over voltage fault during the data identification process, it can prolong the acceleration/deceleration time P0.08 and P0.09 properly.

- If the inverter power does not match the motor power, motor data identification at standstill should be selected. Before identification, manually change the no-load current P9.05 to about 40% of the motor rated current P9.04.
- If the motor parameters are given, please enter the parameters to P9.05 ~ P9.09 directly. If the motor parameters are not given, please execute the motor data identification. The magnetic flux saturation coefficient value in P9.10 ~ P.14 is automatically set after motor data identification, eliminating the need of setting by the user.
- During the process of motor data identification, “-At-” will appear on the operation panel.

P9.16	Motor overload protection	00 ~ 12(00)
P9.17	Motor over temperature protection threshold	0.00 ~ 10.00 V (10.00V)
P9.18	Motor overload protection time	0.5 ~ 30.0 min (10.0min)

This function can be used to protect the motor.

P9.16 Motor overload protection	
Ones place	Protection mode 0: Motor current mode 1: Sensor mode 2: No action
Tens place	Low speed de-rated 0: Action (applicable to common motor) 1: No action (applicable to variable frequency motor)

The ones place of P9.16 determines whether the motor overload protection is to be executed and whether the motor overload protection employs current mode or sensor mode.

0: Motor current mode: Overload is calculated in accordance with motor current, running frequency and running time and compared with the motor overload protection time determined by P9.18. Once the accumulated overload time is reached, the inverter will report “E.oL2” motor overload fault.

Note:

The time calculation for overload protection continues during running and stop status, the value will be reset after power off.

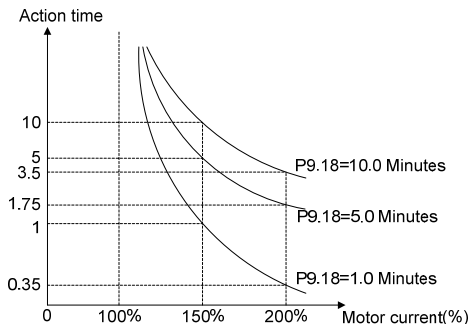

Figure6-33 Motor overload protection characteristics curve (constant torque)

1: Sensor mode. Compare the analog feedback value of the thermal sensor installed on the motor with the present sensor protection threshold P9.17. If the feedback value is higher than that protection threshold, the inverter will report "E.Ptc" motor over temperature fault immediately, without inverse time lag characteristics.

Note:

When this protection mode is employed, an analog channel is required to be set the function to "5: Motor temperature feedback" for the thermal sensor, refer to parameter description of P6.21.

2: No motor protection action, indicating that the inverter will not protect the overload status of the motor. It must be used with great caution.

Tens place of P9.16 determines whether de-rated at low speed :

0: Action: The heat sink effect will become worse when the motor is running at low speed and the motor is de-rated according to the motor overload protection time as determined in P9.18.

1: No action: For some special motors, such as variable frequency motor, "no action" can be selected when de-rated at low speed. It must be used with great caution.

6.11 Control Parameters (Group PA)

PA.00	Switching frequency	0.7 ~ 16.0 kHz (Factory)
PA.01	Switching frequency automatic adjustment	0 ~ 1(1)

Switching frequency has an important impact on operations of inverter and motor. When switching frequency increases, the motor loss, motor temperature rising and motor noise will be decreased. If switching frequency decreases, the inverter temperature rising, the leakage current of motor and external radiation interference will be decreased.

PA.01 can determine automatically the suitable carrier frequency according to inverter temperature.

0: Non-auto adjustment, switching frequency will not be adjusted automatically. Under favorable circumstances as regards ventilation and heat sink, all loads need to be operated with low noise, setting higher switching frequency PA.00 and setting PA.01 to 0.

1: Auto-adjustment, adjust automatically switching frequency through temperature check according to the load. Maintain continuously reliable operation by keeping operating with low noise at light load and excellent effect of inverter temperature rising at heavy load.

Note:

The default value of PA.01 is 1 in E5-H series, the default value of PA.01 is 0 in E5-A series.

PA.02	Slip compensation	0.0 ~ 300.0 % (100.0%)
-------	-------------------	------------------------

The function is used to keep the motor speed constant if load fluctuation or under heavy load.

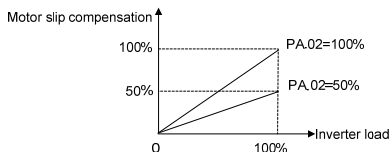

Figure 6-34 Slip compensation gain

PA.03	Droop control	0.00 ~ 10.00 Hz (0.00Hz)
-------	---------------	--------------------------

When several inverters drive one load, the function can distribute the load automatically between inverters and make them work cooperatively. For example, when some inverters run an assembly line, this function can be used to balance loads, allocate loads between inverters at different power levels in proportion to the power, and thus ensure the assembly line operate properly. Each inverter adjusts output frequency automatically according to its load condition and lifting ratio set by droop control.

PA.04	Current limit selection	0 ~ 1(1)
PA.05	Current limit level	20.0 ~ 200.0 % (160.0%)

PA.04 current limit selection:

0: Disabled

1: Enabled

The current limit function is used to prevent the output current exceeds the current limit level (PA.05).

The function is especially applied to applications of suddenly changed speed or load.

If current limit function is enabled, when the current exceeds current limit level (PA.05), the inverter will turn into current limit status. If the current level drops below current limit value (PA.05), exit the current limit status automatically, then normal operation will continue.

Note:

- Current limit level PA.05=160.0% indicates 1.6 times of rated current of inverter.
- Under current limit status, the speed will be decreased. The current limit function is not appropriate for systems that can not reduce speed, otherwise will loss control.
- The setting range is from 20.0% to 150.0% and the default value is 120.0% for E5-A series.

PA.06

Auto voltage regulation

000 ~ 111(101)

PA.06 Auto voltage regulation	
Ones place	Over voltage regulation 0: Disabled 1: Enabled
Tens place	Under voltage regulation 0: Disabled 1: Enabled
Hundreds place	Over-modulation 0: Disabled 1: Enabled

DC bus voltage will rise when motor with large inertial load stops rapidly, or a short time regenerative braking happens for load abrupt changes when the motor is running, thus may cause over voltage protection. Over voltage regulation is used to decrease the braking torque to control the DC bus voltage to prevent over voltage fault through adjusts output frequency and auto prolongs deceleration time.

When power supply voltage decreases or has instantaneous power failure, DC bus voltage will also decrease. The function of under voltage regulation is use to decrease the motor speed through decreasing the output frequency, the load inertial energy feedback to DC bus to keep DC voltage higher than the under voltage value, avoid stop by under voltage. Under voltage regulation is very effective in applications such as centrifugal pump and fan.

Over-modulation is used to increase the output voltage and enhance the output capacity under low grid voltage input or heavy load.

Note:

If dynamic braking is enabled and PA.09 has been set to "1", over voltage regulation function is disabled.

PA.07

Energy-saving rate

0 ~ 50 % (0%)

This parameter is used to decrease the output voltage automatically when the loads decrease under proper operation to maximally decreases reactive power to offer more energy savings. The greater the parameter setting, the more visible the energy saving effect achieves, but the longer the response time lasts from energy saving condition to normal operation status.

Note:

- This function is inactive during acceleration and deceleration process.
- The function applies to variable torque loads such as fan and pump. If used in constant torque loads and rapidly changing loads applications, the function will result in delayed control response.

PA.08

Magnetic flux braking selection

0 ~ 1(1)

0: Magnetic flux braking is disabled

1: Magnetic flux braking is enabled

When the motor decreases, the motor can be rapidly decelerated if magnetic flux braking is selected. The energy of the mechanical system is changed to thermal energy in the motor during the braking process.

But if the function is selected, the output current will be larger than the function is not selected.

PA.09

Dynamic braking selection

0 ~ 1(0)

The parameter of PA.09 enables the dynamic braking function.

0: Dynamic braking is disabled

1: Dynamic braking is enabled

For large rotating inertia applications and when rapid stop by braking is required, select matched braking unit and braking resistance and setting PA.09 to 1.

Note:

If external braking unit is installed, you also need to set this parameter to 1.

PA.10

Braking unit hysteresis voltage

0 ~ 30 V(0V)

PA.11

Braking unit action voltage

650 ~ 750 V(720V)

Braking unit action voltage PA.11 is only applied to inverter with built-in braking unit. Action voltage of braking unit can be selected by parameter PA.11. The motor can be stopped rapidly by energy braking with the appropriate action voltage.

Note:

Setting PA.09 to 1 when using braking unit. For built-in braking unit and braking resistor, refer to 1.9.

PA.12

Special fault activated selection

000 ~ 111(100)

Generally, when inverter produces a fault, for some special fault, the fault output can be set independent.

PA.12 Special fault activated selection	
Ones place	Under voltage fault 0: Disabled 1: Enabled
Tens place	Auto reset interval period 0: Disabled 1: Enabled
Hundreds place	Fault locking 0: Disabled 1: Enabled

Ones place is used to enable the under voltage fault output. Under low voltage status, such as during power on, during power off, under voltage, select the fault output is enabled or disabled by multi function output terminal.

Tens place is used to enable the fault output during automatic reset interval period. The real fault is not output during automatic reset interval period by default setting. Refer to PA.21 and PA.22 instructions.

Hundreds place is used to set the fault locking function, If fault locking function is enabled, if there was a fault during the last outage, the fault will still be output after power on next time. Refer to PA.20 instruction.

PA.13	Inverter or motor overload pre-alarm	000 ~ 111(000)
PA.14	Overload pre-alarm detection level	20.0 ~ 200.0 % (130.0%)
PA.15	Overload pre-alarm detection time	0.1 ~ 60.0 s (5.0s)

Overload pre-alarm function can realize indication of pre-setting overload status or alarm stop.

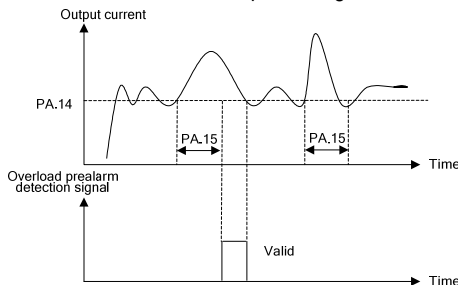

Figure 6-35 Overload pre-alarm detection signal

PA.13 determines overload pre-alarm detection mode and conditions.

PA.13 Inverter or motor overload pre-alarm	
Ones place	Detection mode selection 0: Motor overload pre-alarm, relative to motor rated current 1: Inverter overload pre-alarm, relative to inverter rated current
Tens place	Action selection after overload pre-alarm 0: Continue to run 1: Report overload fault and stop
Hundreds place	Detection conditions selection 0: Detection all the time 1: Detection only at constant speed

PA.13 ones place is used to determine overload mode is motor overload pre-alarm or inverter overload pre-alarm.

PA.13 tens place is used to determine continues running or output fault if the actual output current exceeds PA.14 (overload pre-alarm detection level) setting and the last time is longer than PA.15 (overload pre-alarm detection time).

If ones place is set to "0", "E.oL2" will be displayed.

If ones place is set to "1", "E.oL1" will be displayed.

PA.13 hundreds place is used to determine when the overload pre-alarm function detection is activated.

Note:

The function of multi function output terminal (P7.00 to P7.02) can be set to "4: Overload detection signal (OL)" to display overload pre-alarm signal.

PA.16	Faults shield and alarm attribute setting 1	0000 ~ 2222(0020)
PA.17	Faults shield and alarm attribute setting 2	0000 ~ 2222(0020)
PA.18	Faults shield and alarm attribute setting 3	0000 ~ 2222(2000)
PA.19	Faults shield and alarm attribute setting 4	0000 ~ 2222(0002)

These parameters are used to select various actions when some faults occur. When these faults occur under some special circumstances, can only output alarm signal but not stop even shield the fault.

Ones place, tens place, hundreds place and thousands place displayed from PA.16 to PA.19 can be set:

0: Fault is not shielded, output fault signal and coast to stop.

If the fault occurs, output to motor is cut off, the motor coast to stop, the fault code is displayed on the operation panel, if multi function output terminal function is set to “14”, the output is enabled.

1: Fault is not shielded, output alarm signal but continue to run.

If the fault occurs, continue to run, the fault code is displayed on the operation panel, if multi function output terminal function is set to “15”, the output is enabled.

2: Fault is shielded, not output fault or alarm signal, continue to run.

The fault is completely shielded, the fault code will not be displayed on the operation panel, and whatever multi function output terminal function is set to “14” or “15”, the output is disabled.

PA.16 Faults shield and alarm attribute setting 1	
Ones place	Motor or motor cable is short circuited to ground
Tens place	Power supply is switch off during running process
Hundreds place	Power supply is abnormal
Thousands place	Output phase loss

PA.17 Faults shield and alarm attribute setting 2	
Ones place	EEPROM fault
Tens place	Pre-charging contactor fault
Hundreds place	Temperature sensor abnormal
Thousands place	Encoder disconnection

PA.18 Faults shield and alarm attribute setting 3	
Ones place	+10V output error
Tens place	Analog input error
Hundreds place	Motor over temperature (PTC)
Thousands place	Communication fault 1(operational panel 485)

PA.19 Faults shield and alarm attribute setting 4	
Ones place	Communication fault 2(terminal 485)
Tens place	Software version compatibility
Hundreds place	Reserved
Thousands place	Reserved

Note:

To change factory setting, please contact the distributor or manufacturer.

PA.20	Fault locking function selection	0 ~ 1(0)
-------	----------------------------------	----------

0: Fault is not locked.

1: Fault is locked: Allowing re-display faults that is occurred last power-off after power-on, fault must be RESET before start.

Note:

➤ Whether to output fault indication simultaneously is decided by parameter PA.12. Refer to PA.12 instruction.

➤ “-LU-” under voltage cannot be locked upon next time power on as a fault.

PA.21	Automatic reset times	0 ~ 20(0)
-------	-----------------------	-----------

PA.22	Automatic reset interval	2.0 ~ 20.0 s (2.0s)
-------	--------------------------	---------------------

The function is used to automatic reset for ordinary fault. The inverter will start to run automatically again after automatic reset interval PA.22. If the fault still exists as the inverter starts again after automatic reset times PA.21, it will output fault and stop. For faults such as over-current or over-voltage occurred occasionally, the function can be used if the equipment need to keep running without manual reset.

Note:

➤ For fault E.PCU, E.rEF, E.AUt, E.FAL, E.oUt, E.ot1, E.ot2, E.Cur, E.GdF, E.LV1, E.CPy, E.dL4, E.loF and E.oL3, automatic reset function can not automatic reset these faults.

➤ The inverter will not check fault during automatic reset interval.

6.12 Enhanced Function Parameters (Group Pb)

Pb.00	Jump frequency lower limit 1	0.00 ~ 300.00 Hz(0.00Hz)
Pb.01	Jump frequency upper limit 1	0.00 ~ 300.00 Hz(0.00Hz)
Pb.02	Jump frequency lower limit 2	0.00 ~ 300.00 Hz(0.00Hz)
Pb.03	Jump frequency upper limit 2	0.00 ~ 300.00 Hz(0.00Hz)
Pb.04	Jump frequency lower limit 3	0.00 ~ 300.00 Hz(0.00Hz)
Pb.05	Jump frequency upper limit 3	0.00 ~ 300.00 Hz(0.00Hz)

These parameters are used to avoid mechanical resonance. When the reference frequency between the jump frequency upper limit and jump frequency lower limit, the motor will run at jump frequency lower limit when acceleration, run at jump frequency upper limit when deceleration, as shown in the following figure.

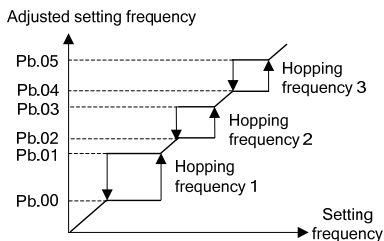

Figure 6-36 Upper and lower limit of jump frequency

Pb.06	UP/DN single step frequency setting without integral function	0.00 ~ 10.00Hz(0.10Hz)
-------	---	------------------------

When Pb.08 and Pb.10 setting without integral function, UP/DN single step increase or decrease frequency define by Pb.06.

Pb.07	Magnification acceleration/deceleration time and UP/DN change direction selection	0000 ~ 1111(1000)
-------	---	-------------------

Pb.07 Magnification acceleration/deceleration time and UP/DN change direction selection	
Ones place	Acceleration/deceleration time 0: ×1 1: ×10
Tens place	Reserved
Hundreds place	Reserved
Thousands place	UP/DN change direction 0: Enabled 1: Disabled

Pb.07 ones place is used to enlarge 10 times acceleration/deceleration time. If Pb.07 ones place is set to 1:

$$\text{The real acceleration and deceleration time} = P0.08/P0.09 \times P10$$

Pb.07 thousands place is used to determine whether the UP/DN can change the running direction.

Pb.08	Operational panel \wedge/\vee digital regulating frequency control	0000 ~ 0221(0001)
Pb.09	Operational panel \wedge/\vee integral rate	0.1 ~ 50.0 s (2.0s)

Through operational panel \wedge/\vee to regulate frequency and the frequency value will be saved and superimposed on other frequency as final frequency.

The parameter Pb.08 determines the function of operation panel \wedge/\vee .

The parameter Pb.09 is used to set the time that refresh frequency increment or decrement for one time when adjusting with \wedge/\vee continuous.

Pb.08 Operational panel \wedge/\vee digital regulating frequency control	
Ones place	Save after power off 0: Saved after power-off 1: Cleared after power-off
Tens place	Save after stop 0: Saved in stop status 1: Cleared after receive a stop command 2: Cleared in stop status
Hundreds place	Operational panel \wedge/\vee enabled setting 0: Only active when main reference is P0.05 1: Always active 2: Always inactive
Thousands place	Integral function selection 0: With integral function 1: Without integral function

Pb.08 ones place is used to set whether save the incremental part regulating by operational panel \wedge/\vee after power off

- 0: Saved after power-off
- 1: Cleared after power-off

Pb.08 tens place is used to set whether save the incremental part regulating by operational panel \wedge/\vee after stop.

- 0: Saved in stop status
- 1: Cleared after receive a stop command
- 2: Cleared in stop status

Pb.08 hundreds place is used to set when the operational panel \wedge/\vee regulating function is activated.

- 0: Only active when the frequency reference is P0.05 (P0.04=0)
- 1: Always active
- 2: Always inactive

Pb.08 thousands place is used to activated the operational panel \wedge/\vee regulating integral function.

- 0: With integral function. When the operation panel \wedge/\vee adjustment is used to set the frequency, the consistent adjustment in one direction has integral effect. The step length of adjustment starts from 0.01Hz, after every 10 times of adjustment, the step length will be increased by 10 times.
- 1: Without integral function. When the operation panel \wedge/\vee adjustment is used to set the frequency, the step length of the adjustment is determined by parameter Pb.06.

Note:

For process closed loop PID, the closed loop reference also can be adjusted by operational panel \wedge/\vee . Then adjustment value of \wedge/\vee is regarded as analog superimposed on the closed loop reference. The minimum step length is 1mV.

Pb.10	Terminal UP/DN digital regulating frequency control	0000 ~ 1221(0001)
Pb.11	Terminal UP/DN integral rate	0.1 ~ 50.0 s(2.0s)

Pb.10 Terminal UP/DN digital regulating frequency control	
Ones place	Save after power off 0: Saved after power-off 1: Cleared after power-off
Tens place	Save after stop 0: Saved in stop status 1: Cleared after receive a stop command 2: Cleared in stop status
Hundreds place	Terminal UP/DN enabled setting 0: Only active when main reference is P0.05 1: Always active 2: Always inactive
Thousands place	Integral function selection 0: With integral function 1: Without integral function

Pb.10 and Pb.11 are the same as the usage of operational panel \wedge/\vee . For functions of terminal UP/DN, refer to instructions of P5.00~P5.06.

Pb.12	Reach pre-set running time action selection	00 ~ 11(00)
Pb.13	Continuous running time setting	0.0 ~ 6553.5 min (0.0 min)
Pb.14	Accumulative running time setting	0.0 ~ 6553.5 min (0.0 min)

Pb.13 Reach pre-set running time action selection	
Ones place	Continuous running time reached 0: Continue running 1: Stop and alarm
Tens place	Accumulative running time reached 0: Continue running 1: Stop and alarm

This parameter is use for inverter automatic stop and alarm or continue running once running time reaches the user preset time. The parameters of Pb.13, Pb.14 defaults to 0, not timing.

From respond the run command, continuous running time reaches continuous running time setting (Pb.13), can output this signal through Y1/Y2 terminal or relay terminal , and the Y1/Y2 terminal function number (P7.00/P7.01) or relay terminal function number (P7.02) is set to "18: continuous running time reached". From the power on, running time reaches accumulative running time setting (Pb.14), can output this signal through Y1/Y2 terminal or relay terminal, and the Y1/Y2 function number (P7.00/P7.01) or relay terminal function number (P7.02) set to "17: accumulative running time reached".

Note:

- Accumulative running time and continuous running time will be reset to 0 if power off.
- Continuous running time will be reset to 0 in stop status even power on.
- Accumulative running time will not be reset to 0 in stop status. If accumulative running time output signal is enabled, will become disabled in stop status and be reset to 0.

Pb.15	Automatic restart	0 ~ 1(0)
Pb.16	Automatic restart waiting time	0.0 ~ 20.0 s (0.5s)

0: Disabled

1: Enabled

After a power failure, the function supports automatic restart the unit if power on again. This function should be used judiciously.

When automatic restart function is activated, if the inverter in running status before power off, it will restart automatically if power on again under any run command channel, such as operation panel, terminal or host computer.

When automatic restart function is activated, if P0.06=1 and the FWD or REV terminal is enabled when power on, the inverter will start automatically without the need for the personal to intervene. This function should be used judiciously.

Note:

If this function does required, to ensure this function is actually valid under terminal run command channel, please don't change the status of run command terminal after power off.

Pb.17	Pre-set frequency	0.00 ~ 300.00 Hz (0.00Hz)
Pb.18	Pre-set frequency operating time	0.0 ~ 3600.0 s(0.0s)

When start the inverter, the reference frequency is pre-set frequency and lasts pre-set frequency operating time Pb.18, then other frequency reference is enabled.

Pb.19	Wake-up frequency	0.00 ~ 300.00 Hz(0.00Hz)
Pb.20	Sleep frequency	0.00 ~ 300.00 Hz(0.00Hz)

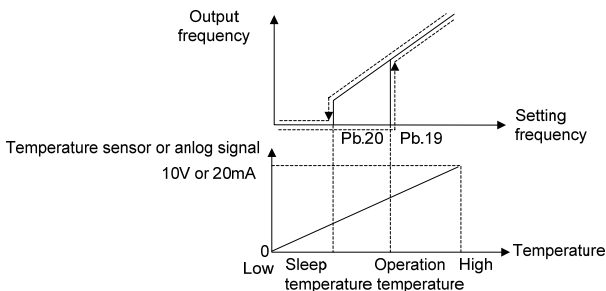

Figure 6-37 Wake-up and sleep frequency operation

This function supports sleep function and energy saving operation. After receive a run command:

Reference frequency \geq Pb.19, start and accelerate to reference frequency

Reference frequency \leq Pb.20, decelerate to 0 Hz

Proper setting the value can avoid the start and stop frequently. The function often used for situations such as air condition, fan and pump, convert the analog of temperature or pressure to frequency to control automatic start and stop.

Pb.21	Fan and pump control mode selection	0 ~ 3(0)
Pb.22	Forced energy saving rate reference	0 ~ 50% (10%)

The two parameters are used to set control mode for fan and pump.

0: Basic running mode

1: Pre-overload decelerate frequency model

If this mode is selected, before overload, through real-time monitoring the load to achieve the inverter automatically reduces the running frequency in order to ensure automatically out of overload running. That may exist automatically reduces the running frequency when using this mode.

2: Forced energy saving mode 1(square type load)

If this mode is selected, according to Pb.22 setting, the inverter automatically determines the frequency upper limit to work in order to meet the square type load forced energy-saving rate requirements setting in Pb.22.

3: Forced energy saving mode 2(cube type load)

If this mode is selected, according to Pb.22 setting, the inverter automatically determines the frequency upper limit to work in order to meet the cube type load forced energy-saving rate requirements setting in Pb.22.

Note:

- This function is only enabled when setting P0.03 to 0
- The higher forced energy saving rate settings, the lower operating frequency upper limit of inverter automatically determines.

Pb.23	Parameters copy	0 ~ 5(0)
-------	-----------------	----------

Parameters copy function can be realized through operation panel.

0: No operation. When upload or download is completed, the parameter is automatically restored to 0.

1: Upload parameters. Press **PRG** key to upload parameters to the operation panel after setting, and will display percentage of copy process after indicating "LoAd".

2: Download parameters (without motor parameters). Press **PRG** key to download parameters to the inverter, and will display percentage of copy process when indicating "CoPy". Motor parameters in Group P9 will not be downloaded to the inverter with this operation.

3: Download parameters (all parameters). Press **PRG** key to download parameters to the inverter after setting, and will prompt percentage of copy process when indicating "CoPy".

4: Upload is not allowed. The function is use to avoiding deleting parameters that have been copied to the operation panel. After setting this function, "HoLd" will be displayed on the operation panel when conducting parameters upload.

5: Upload is allowed, allowing uploading parameters to the operation panel after setting.

Note:

- After operation, Pb.23 will be automatic returned to "0". "E.CPy" will be displayed if occur copy error.
- The parameters for E5, V5 and V6 series cannot be copied each other. And the copy operation can be performed only when the two inverters for upload and download (d1.09) are consistent.
- The copy function can be completed only when the power supply is switched off completely and power on again.

6.13 Communication Parameters (Group PC)

Note:

Terminal 485 only available for "E5-H-4T**G-63", "E5-H-4T**G-34" non-standard series and E5-A series. So group PC is used for above series.

PC.00	Communication baud rate	4 ~ 8(5)
PC.01	Data format	0 ~ 2(0)
PC.02	Local address	1 ~ 247(1)

The inverter supports international Modbus RTU protocol. Refer to the appendix A.

PC.00 is used to set the communication baud rate.

4: 4800bps

5: 9600bps

6: 19200bps

7: 38400bps

8: 57600bps

PC.01 is used to set communication format, odd-even check.

0: 1-8-1 format, without check

1: 1-8-1 format, even check

2: 1-8-1 format, odd check

PC.02 is used to set the local address. Broadcast address is "0", slave address range is "1~247", "248~255" is reserved.

PC.03	Communication parameters setting	000 ~ F0F(303)
-------	----------------------------------	----------------

Ones place: Terminal RS485 setting	
bit0	0: Without reply 1: Reply if communication with host computer
bit1	0: No reply if communication disconnected 1: Reply if communication disconnected
bit2	0: Communication will not detect password 1: Communication will detect password
bit3	0: 0x06 and 0x10 command communication write data in RAM 1: 0x06 and 0x10 command communication write data to EEPROM
Tens place: Reserved	
Hundreds place: Operation panel RS485 setting: Same as ones place	

Note:

If change parameter through communication frequently, it is suggest setting PC.03 to 303 to write data in RAM.

PC.04	Master-slave mode	0 ~ 2(0)
PC.05	Operating Address from master to slave (set by master)	0 ~ 2(0)
PC.06	Slave receive value proportional (set by slave)	0.00 ~ 10.00(1.00)

PC.04 master-slave mode:

0: SCIA is slave mode and SCIB is slave mode

1: SCIA is master mode and SCIB is slave mode

2: SCIA is slave mode and SCIB is master mode

PC.05 master to slave operation address (set by master), the slave can save the data sent from master into the P0.05, P8.00 or P8.01, that is determine by master parameter PC.05:

0: P0.05

1: P8.00

2: P8.01

The inverter provides two communication ports. SCIA is a port connecting with operation panel, and SCIB is the terminals of 485+ and 485-.

Slave mode: In common applications, the inverter operates in slave mode (PC.04=0) and responses to external instructions.

In the master mode, the inverter actively sending running frequency to other devices, this function is often applied in multi-machines operate synchronously applications.

When master mode is selected, this inverter is set as a master to send running frequency to other inverters. When the slave receives frequency sent from the master, it will store the frequency to the parameter determine by master parameter PC.05. For example, if the master sending running frequency to salve parameter P0.05, set master parameter PC.05 to 0.

If inverter master mode is set for SCIA/SCIB and operation panel has been inserted, the operation panel will get priority, and the function of inverter as master mode will lose effect automatically. If the operation panel is removed, after 10 seconds the inverter will return to master mode.

PC.06 slave setting frequency proportional coefficient (set by the slave):

The parameter is only enabled for the slave, it is used to set the slave data coefficient receive from the master.

$$\text{Slave data} = \text{PC.06} \times \text{running frequency sent by master}$$

6.14 Controlled by Manufacture Parameters 1 (Group PE)

PE.00 ~ PE.06	Reserved	0000 ~ FFFF (factory)
PE.07	Oscillation suppression parameter 1	0 ~ 65535 (0004)
d0.02	Oscillation suppression parameter 2	0.000 ~ 65.535 (0.010)
PE.09 ~ PE.22	Reserved	0000 ~ FFFF (factory)
PE.23	A11 zero drift correction	0 ~ 65535 (2048)
PE.24	A12 zero drift correction	0 ~ 65535 (2055)
PE.25	A12 zero drift correction	0 ~ 65535 (2055)
PE.26	Parameters save selection after power off	0 ~ 1 (0)
PE.27 ~ PE.29	Reserved	0000 ~ FFFF (factory)

6.15 Fault Record Parameters (Group d0)

d0.00	Fault record 2	0 ~ 62(0)
d0.01	Fault record 1	0 ~ 62(0)
d0.02	Fault record 0 (Latest)	0 ~ 62(0)
d0.03	Bus voltage of latest fault	0 ~ 65535 V (0V)
d0.04	Current of latest fault	0.0 ~ 6553.5 A (0.0A)
d0.05	Frequency of latest fault	0.00 ~ 300.00 Hz (0.00Hz)

The inverter can record the latest three fault code serial number (see 7.1 list of fault and alarm information) and bus voltage, output current and running frequency when fault recently occurred.

Note:

Under-voltage display (LU), the parameters of fault type and fault data will not be saved.

d0.06	Accumulative power-on time	0.000 ~ 65.535 kh (0.000kh)
d0.07	Accumulative running time	0.000 ~ 65.535 kh (0.000kh)
d0.08	Heat-sink maximum temperature record	0.0 ~ 100.0 °C (0.0°C)
d0.09	Bus voltage maximum fluctuation record	0 ~ 1000V (0V)
d0.10	Reserved	0.00 ~ 300.00Hz (0.00Hz)
d0.11	E.FAL protection type	0 ~ 5(0)

The inverter automatically record the following information: Accumulative power-on time, accumulative operation time, heat-sink maximum temperature record, bus voltage maximum fluctuation, etc.

When the inverter trip by over current, over voltage, short circuited to ground, output phase imbalance, etc. There may be occur E.FAL fault, D0.11 is used to displayed the E.FAL fault type:

0: None

1: Module protection

2: Over current

3: Over voltage

4: Short circuited to ground

5: Vagueness state, interfere and all of above are possible

6.16 Product Identity Parameters (Group d1)

d1.00	Serial number	0.0 ~ FFFF (factory)
d1.01	Software version of control board	0.00 ~ 99.99 (factory)
d1.02	Software non-standard version of control board	0.00 ~ FF.FF (factory)
d1.03	Software version of operation panel	0.000 ~ F.FFF (factory)
d1.04	Software version of extension card	0.000 ~ F.FFF (factory)
d1.05	Manufacturer's bar code 1	0 ~ 9999 (factory)
d1.06	Manufacturer's bar code 2	0 ~ 9999 (factory)
d1.07	Manufacturer's bar code 3	0 ~ 9999 (factory)
d1.08	Manufacturer's bar code 4	0 ~ 9999 (factory)
d1.09	Operation panel copy identification code	0.00 ~ 655.35 (factory)
d1.10	Control board software identification code	0 ~ 65535 (factory)
d1.11	Reserved	0 ~ 65535 (factory)

6.17 Display Parameters (Group d2)

d2.00	Heat-sink 1 temperature	0.0 ~ 100.0° C (0.0° C)
d2.01	Terminal count value	0 ~ 65535 (0)
d2.02	AI1 percentage after curve transformation	0.0 ~ 100.0 % (0.0%)
d2.03	AI2 percentage after curve transformation	0.0 ~ 100.0 % (0.0%)
d2.04	AI3 percentage after curve transformation	0.0 ~ 100.0 % (0.0%)
d2.05	DI percentage after transformation	0.0 ~ 100.0 % (0.0%)
d2.06	Operation panel \wedge/\vee digital adjustment value	0 ~ 65535 (0)
d2.07	Terminal UP/DN digital adjustment value	0 ~ 65535 (0)
d2.08	Software compile date	0 ~ FFFF (factory)
d2.09	X terminal status	0 ~ FFFF (0000)
d2.10	Reference voltage 1 (percentage)	0.0 ~ 100.0 % (factory)
d2.11	Reference voltage 2 (percentage)	0.0 ~ 100.0 % (factory)
d2.12	AI fault source display	0 ~ 5 (factory)
d2.13	Output current detection fault source display	0 ~ 6 (factory)
d2.14	Frequency corresponding to motor rotation speed	0.00 ~ 655.35Hz (0.00Hz)
d2.15	Reserved	0 ~ 65535 (0)
d2.16~d2.24	Reserved	0 ~ 65535 (factory)

Parameters in d2 group are read only parameters.

d2.06 and d2.07 is used to display the adjustment value of operation panel \wedge/\vee and terminal UP/DN. d2.09 is used to display the digital input terminal status, 0 indicates terminal is OFF, while 1 indicates ON. Bit 0 to bit6 corresponds to X1 to X7.

d2.12 indicates the fault source of analog input. 1 indicates AI1 exceeding limit, 2 indicates AI2 exceeding limit, 3 indicates AI3 exceeding limit, 4 indicates AV4/AI4 exceeding limit, and 5 indicates AV5/AI5 exceeding limit. Among them 4 and 5 only valid when use EX-PM01.

d2.13 indicates the current detection fault source display. 2 indicates phase W abnormal, 4 indicates phase V abnormal, and 6 indicates phase U abnormal.

d2.14 indicates the frequency corresponds to the actual motor rotation speed under vector control 2 with encoder speed feedback.

6.18 Special Parameters for Constant Pressure Control (Group H0)

H0.00	Close loop function selection for constant pressure control	0 ~ 1 (0)
P0.03	Control mode	0 ~ 3 (0)

H0.00 is used to set the close loop mode for constant pressure control.

0: Constant pressure control function is disabled, the function of H0.01~H0.09 are disabled.

1: Constant pressure control function is enabled, in this control mode. P0.03 must be set to 1.

Note:

If setting H0.00 to 1, close loop reference and close loop feedback percentage display of the operation is pressure reference value and pressure feedback value.

H0.01	The pressure corresponding to maximum analog	0.00 ~ 655.35Mpa (1.00Mpa)
-------	--	----------------------------

This parameter is used to set the maximum pressure corresponding to maximum analog input If pressure setting channel is analog.

H0.02	Lower limit of pressure setting	0.00 ~ 655.35Mpa (1.00Mpa)
H0.03	Upper limit of pressure setting	0.00 ~ 655.35Mpa (0.00Mpa)

H0.02 and H0.03 are used to limit the pressure to upper limit and lower limit. When the setting value exceed the value of H0.02 to H0.03, actual pressure target value take the limit value of H0.02 or H0.03.

H0.04	Pressure setting channel selection	0 ~ 2 (0)
H0.05	Digital pressure setting	0.00 ~ 655.35Mpa (0.40Mpa)

H0.04 is used to select the pressure setting channel.

When H0.04=0, the pressure setting determinate by parameter H0.05.

When H0.04=1, the pressure setting determinate by analog input terminal AI1, the analog 0 to 10V corresponding to 0 to H0.01 setting value.

When H0.04=2, the pressure setting determinate by analog input terminal AI2, the pressure 0 to 20mA corresponding to 0 to H0.01 setting value.

Note:

The input analog through the jumper select 0~10V or 0~20mA

P1.05	Analog feedback close loop control main feedback channel	1 ~ 4 (1)
-------	--	-----------

P1.05 is used to set the actual pressure feedback channel.

When P1.05=1, the actual pressure feedback determinate by analog input terminal AI1, the pressure 0 to 10V corresponding to 0 to H0.01 setting value.

When P1.05=2, the actual pressure feedback determinate by analog input terminal AI2, the pressure 0 to 20mA corresponding to 0 to H0.01 setting value.

When P1.05=3, the actual pressure feedback determinate by analog input terminal AI3.

When P1.05=4, the actual pressure feedback determinate by analog input terminal DI.

Note:

➤ The input analog AI1 and AI2 through the jumper select 0~10V or 0~20mA.

➤ The value of P1.05 and H0.04 can not be set the same channel.

H0.06	Sleep frequency setting	0.00 ~ 300.00 Hz (30.00Hz)
H0.07	Sleep delay time	0.0 ~ 3600.0 s (60.0s)
H0.08	Wake up pressure percentage	0.0 ~ 200.0 % (50%)
H0.09	Exit wake-up delay time	0.0 ~ 3600.0 s (30.0s)

This function realized energy saving control for fan or pump.

When the actual running frequency lower than the sleep frequency setting(H0.06), and last longer than the delay time set in H0.07, the frequency decelerate to 0 Hz.

When the actual pressure feedback lower than wake up pressure percentage (H0.08), and last longer than the delay time set in H0.09, re-enter the PID regulator, the motor start running.

Note:

- In sleep status, the operation panel display “-SL-”
- Sleep delay time H0.07 setting should be longer than acceleration time
- Wake up pressure percentage (H0.08) is percentage of pressure setting
- Pressure setting channel is determine by H0.04

H0.11	Frequency of auto switch acceleration time and deceleration time	0.00 ~ 300.00 Hz (0.00Hz)
H0.12	Acceleration time and deceleration time automatically switch	0 ~ 3 (1)

The function realized auto switch acceleration time and deceleration time during acceleration and deceleration.

When the frequency reference lower than H0.11, the inverter will automatically switch to acceleration and deceleration time define by H0.12.

For example, if running frequency 0 to 10Hz the acceleration and deceleration time is 20.0s. And running frequency is 10.00Hz to maximum frequency acceleration and deceleration time is 6.0s, the parameters should be set: H0.11=10.00Hz,H0.12=1, P0.08=6.0s, P0.09=6.0s, P4.09=20.0s, P4.10=20.0s.

H0.30	Sleep and wake up mode selection	0 ~ 1 (0)
-------	----------------------------------	-----------

When H0.30 is set to 0, sleep and wake up mode according the parameter of H0.00.

When H0.30 is set to 1, sleep and wake up mode according the parameter of H0.31 to H0.34.

H0.31	Wake up pressure setting	0.00 ~ 10.00V (0.00V)
H0.32	Sleep pressure setting	0.00 ~ 10.00V (0.00V)
H0.33	Wake up delay time	0.0 ~ 3600.0s (0.0s)
H0.34	Sleep delay time	0.0 ~ 3600.0s (0.0s)

These parameters realized energy saving for fan or pump.

When PID is set to positive function (setting P8.09 to 0):

If pressure feedback exceeds sleep pressure setting (H0.32), and last longer than sleep delay time (H0.34), the frequency decelerate to 0 Hz.

If pressure feedback lower than wake up pressure setting (H0.31), and last longer than wake up delay time (H0.33), re-enter the PID regulator and acceleration from 0 Hz.

When PID is set to negative function (setting P8.09 to 1):

If pressure feedback lower than sleep pressure setting (H0.32), and last longer than sleep delay time (H0.34), the frequency decelerate to 0 Hz.

If pressure feedback excess wake up pressure setting (H0.31), and last longer than wake up delay time (H0.33), re-enter the PID regulator and acceleration from 0 Hz.

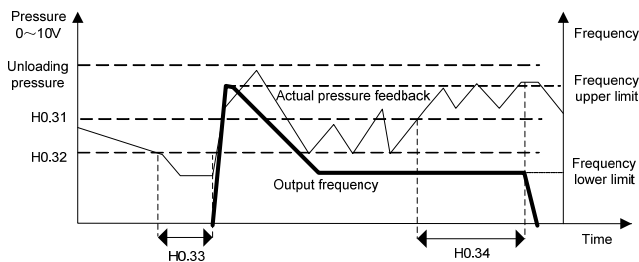

Figure 6-38 Pressure control sleep and wake up mode (positive)

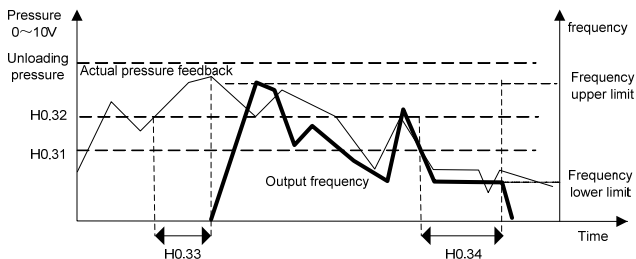

Figure 6-39 Pressure control sleep and wake up mode (negative)

6.19 Special Parameters for EX-DT01 (Group H1)

H1.00	EX-DT01 digital terminal extension card selection	0 ~ 1(1)
-------	---	----------

If EX-DT01 card is installed, H1.00 should be set to 1 to enable the function of EX-DT01.

H1.01	X8 terminal input function selection	00 ~ 99(99)
H1.02	X9 terminal input function selection	00 ~ 99(99)
H1.03	X10 terminal input function selection	00 ~ 99(99)
H1.04	X11 terminal input function selection	00 ~ 99(99)
H1.05	X8 to X11 terminal filter time	0.000 ~ 1.000s (0.001s)

X8 ~ X11 terminal function and X1 ~ X7 terminal function are identical, refer to P5.00 to P5.07 for description.

H1.06	X8 ~ X11 virtual terminal active selection	0 ~ 1 (0)
-------	--	-----------

The parameter is used to set the X8 to X11 virtual terminal. Set to "0" is disabled and "1" is enabled .

H1.07	X8 ~ X11 terminal positive logic or negative logic selection	0 ~ F (0)
-------	--	-----------

X8 ~ X11 terminal positive logic or negative logic selection	
0: Active if current flowing through, positive logic	
1: Active if no current flowing through, negative logic	
bit0	X8 positive logic or negative logic selection
bit1	X9 positive logic or negative logic selection
bit2	X10 positive logic or negative logic selection
bit3	X11 positive logic or negative logic selection

H1.08	Relay RA1 output function selection	00 ~ 47 (00)
H1.09	Relay RA2 output function selection	00 ~ 47 (01)
H1.10	Relay RA3 output function selection	00 ~ 47 (02)

RA1 ~ RA3 terminal function and RA terminal function are identical, refer to P7.02 for description.

H1.11	RA1 ~ RA3 virtual terminal active selection	0 ~ 1 (0)
-------	---	-----------

The parameter is used to set the RA1 to RA3 virtual terminal. Set to "0" is disabled and "1" is enabled .

H1.12	RA1 ~ RA3 terminal positive logic or negative logic selection	0 ~ 7 (0)
-------	---	-----------

RA1 ~ RA3 terminal positive logic or negative logic selection	
0: Active if in magnetizing status, positive logic	
1: Active if not in magnetizing status, negative logic	
bit0	RA1 positive logic or negative logic selection
bit1	RA2 positive logic or negative logic selection
bit2	RA3 positive logic or negative logic selection

H1.13	RA1 output function action delay time	0.0 ~ 999.9s (0.0s)
H1.14	RA2 output function action delay time	0.0 ~ 999.9s (0.0s)
H1.15	RA3 output function action delay time	0.0 ~ 999.9s (0.0s)

6.20 Controlled by Manufacture Parameters 2 (Group A0)

A0.00	Reserved	0000 ~ FFFF(factory)
A0.01	X1 ~ X7, AI1 ~ AI3 terminal positive logic or negative logic selection	0 ~ FFFF(03FF)

A0.01 is used to set the positive logic or negative logic for X1 to X7 and AI1 to AI3. The default is 03FF, positive logic.

X1 ~ X7, AI1 ~ AI3 terminal positive logic or negative logic selection	
0: Negative logic 1: Positive logic	
bit0	X1 positive logic or negative logic selection
bit1	X2 positive logic or negative logic selection
bit2	X3 positive logic or negative logic selection
bit3	X4 positive logic or negative logic selection
bit5	X5 positive logic or negative logic selection
bit6	X6 positive logic or negative logic selection
bit7	X7 positive logic or negative logic selection
AI1	AI1 positive logic or negative logic selection
AI2	AI2 positive logic or negative logic selection
AI3	AI3 positive logic or negative logic selection

A0.02	Reserved	0 ~ 2(0)
A0.03	Auxiliary reference limit percentage	0.0 ~ 100.0% (100.0%)
A0.04~A0.12	Reserved	0 ~ FFFF (FFFF)

6.21 Setting Process for Constant Pressure Control

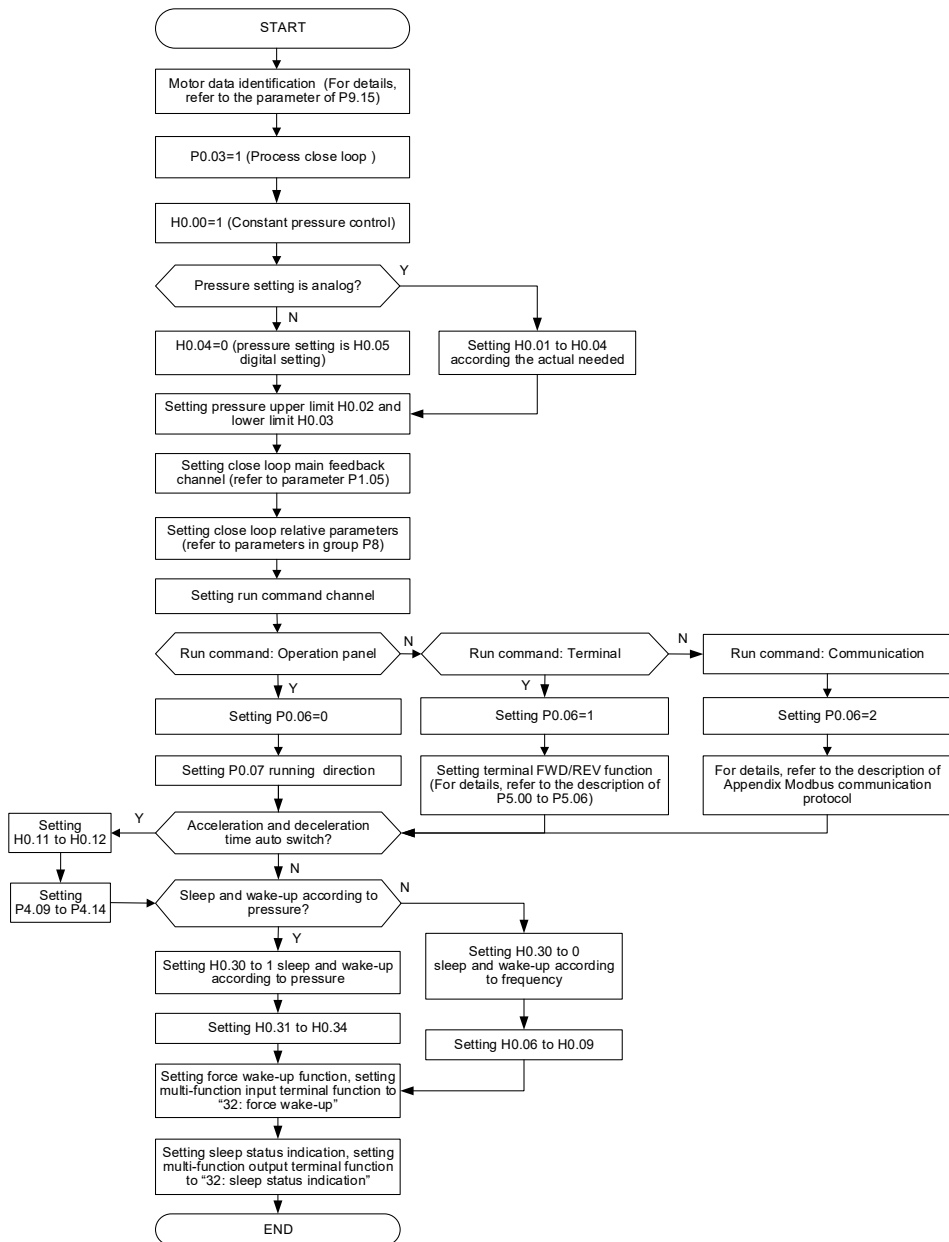

Chapter 7 Troubleshooting

7.1 List of Fault and Alarm Information

This chapter lists all the fault and alarm messages including the possible causes and corrective actions. Once a fault is detected, the following fault code will be displayed on the operation panel, the fault contact output operates, and the output to motor is disable, the motor will coast to stop. For details, refer to the following table to identify and correct the cause of the fault.

For damages on units or questions that can't be resolved, please contact with local distributors/agents, service centers or manufacturer for solutions.

Fault No.	Fault display on panel	Fault description	Possible causes	Corrective actions
1	E.oc1	Over current during acceleration	Low grid voltage	Check input power supply
			Start when the motor is spinning	Restart after the motor at standstill
			Rotating inertial of load is too large or shock load is too heavy	Increase the acceleration time and reduce the sudden change of load
			Improper setting motor parameters	Set motor parameters properly
			Set start frequency too high	Decrease start frequency
			Acceleration time too short	Prolong acceleration time
			V/F curve setting are not correct	Adjust V/F setting and torque boost
2	E.oc2	Over current during deceleration	Low grid voltage	Check input power supply
			Rotating inertial of load is too large	Choose appropriate dynamic braking unit and braking resistor
			Improper setting motor parameters	Set motor parameters properly
			Deceleration time is too short	Prolong deceleration time
			Output power is too small	Replace inverter with higher model
3	E.oc3	Over current at constant speed	Sudden load change of during operation	Decrease load's abrupt frequency change and amplitude
			Improper setting motor parameters	Set motor parameters properly
			Output power is too small	Replace inverter with higher model
4	E.oV1	Over voltage during acceleration	Motor short-circuit to ground	Check motor wiring
			Abnormal input power supply	Check input power supply
			Start when the motor is still rotating	Restart after the motor at standstill
5	E.oV2	Over voltage during deceleration	Motor short-circuit to ground	Check motor wiring
			Rotating inertial of load is too large	Choose appropriate dynamic braking unit and braking resistor
			Deceleration time is too short	Prolong deceleration time
6	E.oV3	Over voltage at constant speed	Motor short-circuit to ground	Check motor wiring
			Abnormal input power supply	Check input power supply
			Rotating inertial of load is too large	Choose appropriate dynamic braking unit and braking resistor
7	E.PCU	Interference protection	Severely interfered by exterior signal	Ask professional technicians to maintain

Fault No.	Fault display on panel	Fault description	Possible causes	Corrective actions
8	E.rEF	Abnormal comparison level	Loose connection of connectors inside the inverter	Ask professional technicians to maintain
			Abnormal switching power supply	Seek for technical support
			Abnormal signal sampling and comparison circuit	Seek for technical support
9	E.AUt	Motor data identification failure	Enabled motor data identification function during motor spinning	Perform motor data identification after the motor at standstill
			Motor data identification overtime	Check whether motor wiring are well connected Length of motor wiring within 100m
			Incorrect setting of motor parameters in group P9	Set motor parameters according to the nameplate on the motor
10	E.FAL	Module protection	Output over current	Check whether the motor the output connection are short circuited Check whether ground is short circuited and whether the load is too heavy
			DC BUS over-voltage	Check the mains power supply Check whether the large inertia load and quickly stop Check the braking unit and braking resistor is property selected
			Output terminal short circuited to ground	Check the motor wiring
			Loose connection of connectors inside the inverter	Ask professional technicians to maintain
11	E.oH1	Heat-sink 1 over temperature protection	Ambient over-temperature	Lower the ambient temperature and strengthen ventilation and heat dissipation.
			Blockage of air duct	Clean the dusts, wool and other foreign matters in the air duct.
			Fan failure	Check whether fan wiring are well connected Replace a new fan
			Inverter module failure	Seek for technical support
			Temperature detection circuit failure	Seek for technical support
12	E.oH2	Heat-sink 2 over temperature protection	Ambient over-temperature	Lower the ambient temperature and strengthen ventilation and heat dissipation.
			Blockage of air duct	Clean the dusts, wool and other foreign objects in the air duct
			Fan failure	Check whether fan wiring is well connected. Replace a new fan of the same model
			Rectifier module failure	Seek for technical support
			Temperature detection circuit failure	Seek for technical support

Fault No.	Fault display on panel	Fault description	Possible causes	Corrective actions
13	E.oL1	Inverter overload protection	Input power under voltage	Check input power supply
			Start when motor is spinning	Start again after the motor at standstill
			Keep overloading for a long period of time	Shorten the overloading time and reduce load
			Too short acceleration or deceleration time	Prolong the acceleration or deceleration time
			V/F curve setting are not correct	Adjust V/F curve setting and torque boost
			Over load condition	Check the load for an over load condition
			Output power is too small	Replace with higher model
14	E.oL2	Motor overload protection	Input power under voltage	Check input power supply
			Motor rotation is blocked or load suddenly changed	Prevent the motor rotation from blocking and reduce the load suddenly changed
			Common motor maintains running under heavy load for a long period of time	Replace the common motor with variable frequency motor or increase the running frequency
			Motor overload protection time is set too small	Increase the motor overload protection time
			V/F curve ratio is set too large	Adjust V/F curve setting and torque boost
			DC braking current is set too high	Reduce the DC braking current
15	E.oUt	Peripheral protection	External terminal fault active	Check the external failure terminal status
			Over voltage stall or over current stall time lasts for more than one minute	Check whether the external load is normal
19	E.CUr	Current detection fault	Current detection circuit failure	Seek for technical support
20	E.GdF	Output short circuited to ground	Wrong connection	Correct the connection error as per the user manual
			Motor abnormal	Replace the motor after performing ground insulation test
			Invert module fault	Seek for technical support
			Ground leakage current at the output side is too large	Seek for technical support
21	E.LV1	Abnormal power off in running status	Mains power fluctuation or momentary power failure	Check the mains power supply
22	E.ILF	Input power fault	Abnormal connection, missing connection or disconnection at the power supply	Check the power connections as per the operational regulations and eliminate the errors of missing connection and disconnection
			Serious imbalance of three phases power supply	Check whether the imbalance of three phases power comply with the requirements
			Capacitor aging	Seek for technical support
			Abnormal snubber circuit	Seek for technical support

Fault No.	Fault display on panel	Fault description	Possible causes	Corrective actions
23	E.oLF	Abnormal output phase loss	Abnormal connection, missing connection or disconnection at the output side	Check the three phase output whether exits missing connection or disconnection
			Imbalance of output three phases	Check whether motor is kept well Switch off the power supply to check whether the terminal characteristics at the output side and DC side are consistent
24	E.EEP	EEPROM failure	EEPROM reading and writing failure	Seek for technical support
25	E.dL3	Pre-charging contactor contact failure	Loose connection inside the inverter	Ask professional technicians to maintain
			Abnormal snubber circuit	Seek for technical support
26	E.dL2	Temperature sensor disconnection	Ambient under temperature	Check whether the ambient temperature complies with the requirements
			The temperature sampling circuit inside the inverter is faulty	Seek for technical support
27	E.dL1	Encoder cable disconnection	Encoder connection is incorrect	Change the encoder cable connection
			Encoder has no signal output	Check whether the encoder and power supply are normal.
			Encoder cable disconnection	Reconnect
			Abnormal parameter setting	Confirm the relevant parameters of encoder are set properly
28	E.P10	+10V power output abnormal	+10V power overload	Increase +10V power load impedance Use externally independent power supply
			+10V and GND is short circuited	Eliminate the short circuit failure
			+10V power terminal circuit failure	Seek for technical support
29	E.AIF	Analog input abnormal	Analog input voltage is too large	Check whether the analog input voltage complies with the requirements
			Analog input circuit failure	Seek for technical support
			Analog input circuit signal is interfered	Increase the P6.22 ~ P6.24 AI filter time
30	E.Ptc	Motor over temperature(PTC)	The motor temperature signal reaches the alarm setting value	Strengthen ventilation and heat dissipation
			Thermistor resistance failure	Check the thermistor
			The sensor protection threshold of the motor is set improperly	Adjust the sensor protection threshold of the motor
31	E.SE1	Communication abnormal 1 (Operation panel RS485)	The communication of operation panel RS485 is disconnected	Check the connection of the equipment communications
			Communication failure of operation panel RS485	Check whether the data receiving and transmission complies with the protocol, whether the check sum is correct and whether the receiving and transmission interval complies with the requirements
			The inverter is set to master mode	Set the inverter to slave mode

Fault No.	Fault display on panel	Fault description	Possible causes	Corrective actions
32	E.SE2	Communication abnormal 2 (Terminal 485)	The communication of terminal RS485 is disconnected	Check the connection of the equipment communications
			The baud rate is set improperly	Set compatible baud rate
			Communication failure of terminal RS485	Check whether the data receiving and transmission complies with the protocol, whether the check sum is correct and whether the receiving and transmission interval complies with the requirements
			The communication of terminal RS485 is time-out	Check whether the communication timeout is set properly and confirm the communication cycle of the application program
			Improper setting of failure alarm parameters	Adjust the failure alarm parameter
			The inverter is set to master mode	Set the inverter to slave mode
33	E.VEr	Version incompatibility	Incompatible software version of the operation panel	Seek for technical support
34	E.CPy	Copy fault	The data error when uploading	Check connection of operation panel
			The data error when downloading	Check connection of operation panel
			Operation panel no parameters is uploaded	Upload the parameters to operation panel first
			Software version incompatible	Check if d1.09 is consistent
36	E.dL4	Expansion card connection abnormal	Expansion card disconnection	Ask professional technicians to maintain
			Expansion card failure	Seek for technical support
37	E.loF	Terminal mutual exclusion check failed	The functions of X1 to X7, AI1, AI2 and DI terminals are set a same function	Modify the settings of X1 to X7, AI1, AI2 and DI terminals and ensure the setting functions are not repeated (excluding null function)
38	E.oL3	Hardware overload protection	Abnormal load	Check whether motor is stalled Replace inverter with higher model
			Abnormal input power supply	Check whether there is phase loss
			Output failure	Check whether the output phase loss or short circuit
63	-LU-	Power supply under voltage	The power supply voltage is lower than the minimum operating voltage	Check input power supply
			Abnormal internal switching power supply	Seek for technical support

7.2 Troubleshooting Procedures

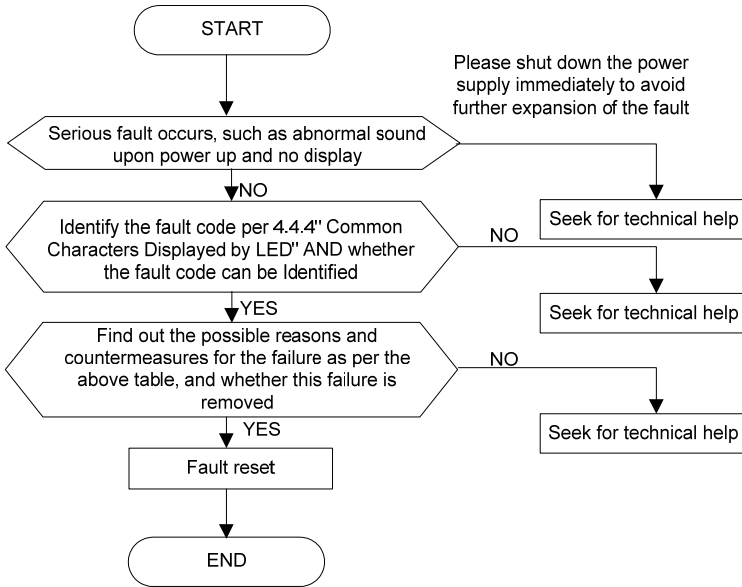

7.3 FAQ

I . Why have abnormal operation?

- (1) Check if motor data identification has been performed. For details, refer to the parameter of P9.15
- (2) For E5-H series, check if the lines for Hall sensor is loosen or dislocated for E5-H-4T18.5GA and above power class, for E5-A series, check if the lines for Hall sensor is loosen or dislocated for E5-A-4T22 and above power class.

II . Why the running frequency kept at 0Hz when run reverse ?

- (1) Check if the frequency is set to 0
- (2) Check if the parameter value of P3.09 is set to 0. If not, change it to 0.

III. Why the braking resistor didn't it work?

- (1) Check if the braking resistor is connected between the main circuit terminals B1 and B2
- (2) Check if the parameter value of PA.09 is set to 1. If not, change it to 1

IV. Why there is large deviation between the analog input and the setting frequency?

- (1) Check if the analog input type is correct and the jumpers of control board for select 0~10V or 0~20mA are properly set. For the analog voltage input, the jumper turn to V side and for the analog current input, the jumper turn to I side
- (2) Check if the analog input curve is properly set, for details, refer to parameters of P6.00 to P6.20

V . Why there is large deviation between the analog output and the running frequency?

- (1) Check if the analog output type is correct and the jumpers of control board for select 0~10V or 0~20mA are properly set. For the analog voltage output, the jumper turn to V side and for the analog current output, the jumper turn to I side
- (2) Check if the analog output curve is properly set, for details, refer to parameters of P7.05 to P7.09

VI. Why report E.AIF analog input abnormal error?

- (1) Check if the analog input type is correct and the jumpers of control board for select 0~10V or 0~20mA are properly set. For the analog voltage input, the jumper turn to V side and for the analog current input, the jumper turn to I side
- (2) Check if the analog input voltage exceeds 11V
- (3) When the analog power supply is inner +10V of the control board, check if the voltage of +10V is lower than 9V or higher than 11V. If yes, check if the resistance value between the +10V and the GND is less than 1K Ω after powered off completely

VII. Why report E.P10 abnormal error?

- (1) Check if the voltage of +10V on the control board is lower than 9V or higher than 11V. If yes, check if the resistance value between +10V and GND is less than 1K Ω after power off completely

VIII. Why the host computer and inverter have abnormal communication?

- (1) Check if the data format, address and baud rate are consistent with the host computer
- (2) Check if the host computer address needs to be added by 1 (that is, "Address +1")
- (3) Check if the host computer adopts Modbus RTU format
- (4) Check if the register address of the host computer is converted to hexadecimal format
- (5) Check if the 485 wires are properly connected

IX. Why there exist abnormality when perform parameter copy?

- (1) The parameters for E5, V5 and V6 series cannot be copied between each other
- (2) The copy operation can be performed only when the parameter value of d1.09 (operation panel copy identification code) are consistent
- (3) After download, should completely power off and power on again, the parameters copy is completed

X. Why the operation panel displayed "8.8.8.8" or no display?

- (1) Check if the operation panel are properly connected to the control board
- (2) Check if the network cable adopt straight-through connection between the operation panel and control board

XI. Why the operation panel can not see the parameter or can not change parameter value?

- (1) If the parameter value can not changed, check if P0.01 is set to 1. If is set to 1, change it to 0.
- (2) Check if the parameter is only read
- (3) If change parameter in running status, check if the parameter could not be changed in running status
- (4) When display is not available, check if the parameter has been encrypted
- (5) When display is not available, check if the operation panel has been locked

XII. How to change the motor direction?

- (1) If run command channel is operation panel, setting P0.07 or press FWD/REV key on the operation panel to change the motor running direction in real time
- (2) If run command channel is terminal, motor running direction is determine by the terminal command
- (3) Operation panel UP/DN key or terminal UP/DN can change the running direction, for details, refer to the parameter of Pb.08 and Pb.10 descriptions
- (4) PID control and composite control can change the motor direction, or details, refer to the parameter of P8.08 description

XIII. Why some model inverter, the fans will run after power on, and some not after power on?

E5-H series:

- (1) 15kW and below power class: The fan will run after power on
- (2) 18.5kW to 45kW : The fan is controlled by the heat-sink temperature
- (3) 55kW to 75kW : The fan will run after power on
- (4) 90kW and above power class: The fan is controlled by the heat-sink temperature and running

command. The fan will run when in running status or the heat-sink temperature reach fan running temperature.

E5-A series:

- (1) 18.5kW and below power class: The fan will run after power on
- (2) 22kW to 55kW : The fan is controlled by the heat-sink temperature
- (3) 75kW to 90kW : The fan will run after power on
- (4) 110kW and above power class: The fan is controlled by the heat-sink temperature and running command. The fan will run when in running status or the heat-sink temperature reach fan running temperature.

XIV. What will happen if the CN1 busbar of the control board is loose or damaged?

- (1) If the CN1 busbar of the control board is loose or damaged, the cannot run or will report various errors. Such as the may display “-LU-” , E.oc1, E.FAL, E.oH1, E.oH2, E.Cur and E.dL3,etc.

XV. How to solve the trouble if occur E.FAL fault?

- (1) When the inverter trip by over current, over voltage, short circuited to ground, output phase imbalance, etc. There may be occur E.FAL fault.
- (2) Check the fault record of d0.00 to d0.05 and d0.11 E.FAL protection type:
d0.11 E.FAL protection type:
 - 0: None
 - 1: Module protection
 - 2: Over current
 - 3: Over voltage
 - 4: Short circuited to ground
 - 5: Vagueness state, interfere and all of above are possible
- (3) Check when occur E.FAL fault:
 - A. Report E.FAL when power on
 - B. Report E.FAL when start to run
 - C. Report E.FAL during running status
- (4) Integrated above data, parameter settings, hardware and the load to solve the problem.

Chapter 8 Maintenance and Inspection

The application environment (such as temperature, humidity, dust and powder, wool, smoke and oscillation), burning and wearing of internal devices and other factors may reduce the service life. To reduce the fault and prolong the service life, it is necessary to perform daily inspections and periodic maintenance.

Note

1. Only the professionals can dismantle and replace the components.
2. Before inspection and maintenance, please make sure that the power supply to the has been shut down for at least ten minutes or the CHARGER indicator is OFF, otherwise, electric shock may be happened (E5-H-4T11G and above power class, E5-A-4T15 and above power class has CHARGER indicator).
3. Do not leave metal components and parts in the inner of inverter, otherwise, inverter me be damaged.

8.1 Daily Inspections

The inverter should be used under the allowable conditions as recommended in this manual and its daily inspections should be performed as the table.

Item	Inspection Contents	Inspection Means	Criteria
Environment	Temperature	Thermometer	-10 ~ +40°C De-rated at 40 to 50°C, and the rated output current shall be decreased by 1% for every temperature rise of 1°C.
	Humidity	hygrometer	5 ~ 95%, no condensing
	Dust, oil, water and drop	Visual check	No dust, no oil, no water and no drop
	Vibration	Special test instrument	3.5m/s ² , 2~ 9Hz 10m/s ² , 9~ 200Hz 15m/s ² , 200~ 500Hz
	Gas	Special test instrument, smell check and visual check	No abnormal smell and no smoke
Inverter	Heat dissipation effect	Special test instrument	Exhaust normal
	Noise	Listen	There is no abnormal noise
	Gas	Smell and visual check	There are no abnormal smell and smoke
	Physical appearance	Visual check	The physical appearance is kept intact
	Heat-sink fan ventilation	Visual check	There are no fouling and wool that block the air duct
	Input current	Ampere-meter	In the allowable operating range, refer to the nameplate
	Input voltage	Voltmeter	In the allowable operating range, refer to the nameplate
	Output current	Ampere-meter	In the rated value range. It can be overloaded for a short while
Output voltage	Voltmeter	In the rated value range	
Motor	Heat dissipation effect	Special test instrument and smell	There are no over temperature and burning smell
	Noise	Listen	There is no abnormal noise
	Vibration	Special test instrument	There is no abnormal oscillation

8.2 Periodic Maintenance

It needs to perform periodic maintenance every three to six months according to the application environment and work conditions.

Item	Inspection Contents	Inspection Means	Criteria
Inverter	Main circuit terminal	Screwdriver/sleeve	The screws are tightened and the cables are kept well
	PE terminal	Screwdriver/sleeve	The screws are tightened and the cables are kept well
	Control circuit terminal	Screwdriver	The screws are tightened and the cables are kept well
	Reliability of internal connections and connectors	Screwdriver and hands	Connection is firm and reliable
	Expansion card connector	Screwdriver and hands	Connection is firm and reliable
	Mounting screws	Screwdriver/sleeve	The screws are tightened
	Cleaning the dusts and powders	Cleaner	There are no dusts and wool
	Internal foreign matter	Visual check	There are no foreign matter
Motor	Insulation test	500VDC megger	Normal

8.3 Component Replacement

Different types of components have different service lives. The service lives of the components are subject to the environment and application conditions. Better working environment may prolong the service lives of the components. The cooling fan and electrolytic capacitor are vulnerable components and should be periodic maintenance. If any fault occurs, the component should be replaced.

Vulnerable Components	Damage Causes	Solutions	Items for Routine Inspection
Fan	Bearing worn, blade aging	Replace	The fan blade has no cracks and rotates normally. The screws are tightened
Electrolytic capacitor	High ambient temperature and electrolyte volatilizes.	Replace	There are no electrolyte leakage, color change, crack and shell inflation. The safety valve is normal Static capacity is equal to or higher than the initial value *0.85



Note

When the inverter is stored for a long time, power connection test should be conducted once within two years and last at least five hours. It can use voltage regulator to gradually increase the value to the rated value after power connection is performed.

8.4 Insulation Test

Insulation test had been perform before leaving–factory, the user should not perform such test as much as possible under general condition. If the test is unavoidable, please perform the test strictly according to the following procedures, or inverter may be damaged.

High voltage testing is strictly prohibited, or inverter may be damaged. If the test is unavoidable, please contact the manufacture.

■ Main Circuit Insulation Test

- ◆ Utilize 500VDC megger to perform test under condition of main power shutdown.
- ◆ Disconnect all the control board circuits to prevent the control circuits from connecting with the test voltage. For the power level of E5–H–4T11G, E5–H–4T15G, E5–A–4T15, E5–A–4T18.5, it must disconnect between the terminal J1 on the drive board and the PE. For the power level of E5–H–4T18.5GA or above, E5–A–4T22 or above, it must disconnect three cables of the surge absorption circuit too. Pack the disconnected cable heads with insulating tapes properly.
- ◆ The main circuit terminal should be connected with public conducting wires:

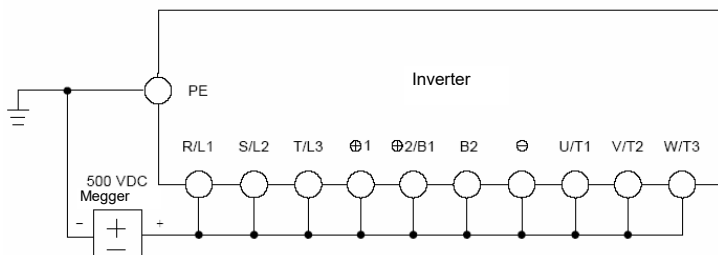

Figure8–1 Main Circuit Insulation Test for E5–H–4T0.75G to E5–H–4T15G, E5–A–4T1.5 to E5–A–4T18.5

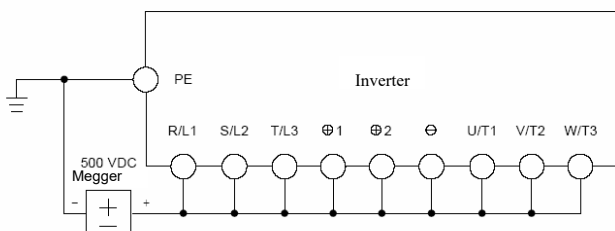

Figure8–2 Main Circuit Insulation Test for E5–H–4T18.5GA to E5–H–4T75GA, E5–H–4T90G to E5–H–4T500G, E5–A–4T22 to E5–A–4T450

- ◆ Megger voltage can only be imposed between the public conducting wire of the main circuit and the PE terminal.
- ◆ The normal indication value of the Megger is 200MΩ or above.

Appendix A Modbus Communication Protocol

1. Support Protocol

Support Modbus RTU protocol, broadcast address is 0, the slave address range is 1 to 247, 248 to 255 is reserved.

2. Interface mode

RS485: Asynchronous, half duplex, LSB sending priority. Low byte is follow the high byte.

Communication port A (Operation Panel RJ45 interface) default data format: 8-N-1, 38400 bps

Communication port B (terminal RS485+/-) default data format: 8-N-1, 19200 bps, see group PC description.

It is recommended to adopt EIA/TIA T568B network cable straight-through connection, the interface of port A is defined as:

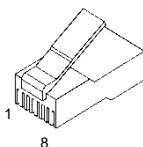

Appendix Figure 1 RJ45 interface

Pin of communication port A	1	2	3	4	5	6	7	8
Signal of communication port A	+5V	GND	485+	485-	485+	485-	GND	+5V
EIA/TIA T568A	White green	Green	White orange	Blue	White blue	Orange	White brown	Brown
EIA/TIA T568B	White orange	Orange	White green	Blue	White blue	Green	White brown	Brown

3. Protocol Format

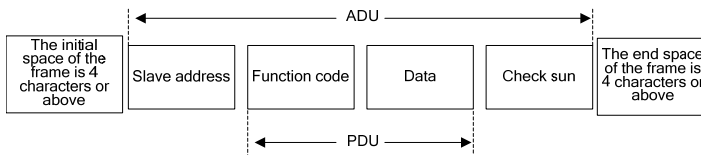

Appendix Figure 2 Protocol Format

ADU (Application Data Unit) check sum is the CRC16 check sum of the front three parts of ADU (slave address, function code and data), through exchange of high byte and low byte.

If the communication request response error, the feedback of PDU(Protocol Data Unit) will be error code and abnormal code. Error code is 0x80, abnormal code shows the error type.

Abnormal codes:

Abnormal code	Definition	Abnormal code	Definition
0x01	Illegal command	0x20	Frame error: frame length error, check sum error
0x02	Illegal data address	0x21	Parameters are unchangeable
0x03	Illegal data, data beyond upper limit or lower limit	0x22	Parameter is unchangeable in running status
0x04	Slave operation failure, the data is in the normal range, but it is invalid	0x23	The parameter is protected by password
0x05	Command is valid, and is in process, mainly occurs when storing data into EEPROM	0x24	Run command source is not through communication, Communication command is not useful
0x06	Slave is busy, mainly occurs when storing data into EEPROM		

4. Function Interpretation

- ◆ Function 0x03 reads multiple parameters and status words

PDU Part Contents	Data Length (Byte)	Range
Request:		
Function code	1	0x03
Start address of register	2	0x0000 ~ 0xFFFF
Number of registers	2	0x0001 ~ 0x0010
Response:		
Function code	1	0x03
Read bytes	1	2*Number of registers
Read contents	2*Number of registers	

- ◆ Function 0x06(0x41) write single parameter

PDU Part Contents	Data Length (Byte)	Range
Request:		
Function code	1	0x06(0x41)
Register address	2	0x0000 ~ 0xFFFF
Register data	2	0x0000 ~ 0xFFFF
Response:		
Function code	1	0x06(0x41)
Register address	2	0x0000 ~ 0xFFFF
Register data	2	0x0000 ~ 0xFFFF

- ◆ Function 0x10(0x42) write multiple parameters

PDU Part Contents	Data Length (Byte)	Range
Request:		
Function code	1	0x10(0x42)
Start address of register	2	0x0000~0xFFFF
Number of register	2	0x0001~0x0010
Bytes of register contents	1	2*Number of registers
Register contents	2*Number of registers	
Response:		
Function code	1	0x10(0x42)
Start address of register	2	0x0000~0xFFFF
Number of register	2	0x0001~0x0010

◆ Function 0x17 read and write multiple parameters

PDU Part Contents	Data Length (Byte)	Range
Request (Response):		
Function code	1	0x17
The start address of reading register	2	0x0000~0xFFFF
The number of reading register	2	0x01~ 0x10
The start address of writing register	2	0x0000~0xFFFF
The number of writing register	2	0x01~0x10
The number of writing register bytes	1	2*Number of registers
The writing register contents	2*Number of registers	
Response:		
Function code	1	0x17
Read the number of register bytes	1	0x02~0x20
Read data contents	2*Read bytes	0x0000~0xFFFF

Operating sequence: Read firstly and rewrite secondly, but the register 0xF080 is an exception, which shall be written firstly and read secondly so as to facilitate the management of the operation panel.

Note:

- In case continuous storage is required, will store from the lower address to upper address, with maximum of 16 parameters being stored in one command.
- If change parameter frequently, such as change setting frequency repeat, the parameter **PC.03 should be set to 303, so the communication change in RAM** or use 0x41(0x42) command replace 0x06 (10) to not stored the value into EEPROM, prevent from damage inner EEPROM.
- The life of EEPROM is about 100000 times, if change parameters frequently, EEPROM service life will be reduced quickly.

5. Parameters Address Definition

Appendix Table-1

Address range	Meaning																												
0x0000~0x1A00	<p>All the parameters with an address, and the parameter values can be read and written through series communication (the write function according to the parameter property define in Chapter 5). The address express with hexadecimal</p> <p>High-order bytes: Parameter group number</p> <p>Low-order bytes: Index in group, convert to hexadecimal</p> <table border="1" style="width: 100%; text-align: center;"> <tr> <td>Group number</td> <td>P0</td> <td>...</td> <td>PE</td> <td>d0</td> <td>d1</td> <td>d2</td> <td>H0</td> <td>H1</td> <td>H2</td> <td>A0</td> <td>C0</td> <td>U0</td> <td>U1</td> </tr> <tr> <td>High-order bytes</td> <td>0x00</td> <td></td> <td>0x0e</td> <td>0x0f</td> <td>0x10</td> <td>0x11</td> <td>0x12</td> <td>0x13</td> <td>0x14</td> <td>0x15</td> <td>0x16</td> <td>0x17</td> <td>0x18</td> </tr> </table> <p>For example, the Modbus address of Pb.23 is : (0x0b<<8)+23=0x0b17</p>	Group number	P0	...	PE	d0	d1	d2	H0	H1	H2	A0	C0	U0	U1	High-order bytes	0x00		0x0e	0x0f	0x10	0x11	0x12	0x13	0x14	0x15	0x16	0x17	0x18
Group number	P0	...	PE	d0	d1	d2	H0	H1	H2	A0	C0	U0	U1																
High-order bytes	0x00		0x0e	0x0f	0x10	0x11	0x12	0x13	0x14	0x15	0x16	0x17	0x18																
0x4000~0x5A00	<p>The parameter address with an attribute word address. The attribute word address:</p> <p>High-order bytes: Parameter group number+0x40</p> <p>Low-order bytes: Index in group, convert to hexadecimal</p> <p>For example, the attribute word address of Pb.23 is : ((0x0b+0x40)<<8)+23=0x4b17</p> <p>The attribute words are defined in the following order: Bit0 ~ Bit2 are unit, Bit3 ~ Bit4 are modifying attribute, Bit5 ~ Bit6 are precision and Bit7 ~ Bit15 are reserved</p>																												
0x8000~0x800D	Control word register																												
0x810B~0x819F	Status word register																												
0xF000~0xF002	Special register for input password authentication.																												
0xF080~0xF084	Read the current value, upper limit, lower limit and factory setting of parameter.																												

◆ Control word registers: 0x8000 ~ 0x800D

Register	Name of Parameters	Register	Name of Parameters
0x8000	Control command word	0x8007	AO2 output host computer percentage
0x8001	Open loop digital frequency reference	0x8008	Y2 output host computer percentage
0x8002	Run command reference source selection	0x8009	Slave setting frequency coefficient
0x8003	Open loop main reference mode	0x800A	Virtual terminal
0x8004	Digital voltage reference (analog feedback)	0x800B	Y1 terminal output function
0x8005	Digital rotation reference(single phase pulse feedback)	0x800C	Acceleration time 0
0x8006	AO1 output host computer percentage	0x800D	Deceleration time 0

Note:
The virtual terminals from LSB to MSB are X1, X2, X3, X4, X5, X6, X7, AI1, AI2, AI3, Y1, Y2 and relay, bit13 ~ bit15 are reserved.

◆ Status word registers 0x810B ~ 0x819F

Register	Name of Parameters	Precision	Register	Name of Parameters	Precision
0x810B	Equipment status word 1		0x8114	Display parameters in stop status	According to parameters
0x810E	Equipment status word 4		0x8116	Display parameters in running status	According to parameters
0x8120	Reference frequency (Hz)	0.01Hz	0x8180	Reference frequency (Hz)	0.01Hz
0x8122	Bus voltage(V)	1V	0x8182	Bus voltage(V)	1V
0x8124	AI1 (V)	0.01V	0x8184	AI1 (V)	0.01V
0x8126	AI2 (V)	0.01V	0x8186	AI2 (V)	0.01V
0x8128	AI3 (V)	0.01V	0x8188	AI3 (V)	0.01V
0x812A	DI (%)	0.1%	0x818A	DI (%)	0.1%
0x812C	External counts	1	0x818C	External counts	1
0x812E	Motor speed	1	0x818E	Motor speed	1
0x8130	Close loop reference (%)	0.1%	0x8190	Close loop reference (%)	0.1%
0x8132	Close loop feedback (%)	0.1%	0x8192	Close loop feedback (%)	0.1%
0x8134	Reserved	0.1%	0x8194	Reserved	0.1%
0x8136	Running frequency (Hz)	0.01Hz	0x8196	Reserved	
0x8138	Output current(A)	0.1 or 0.01A	0x8198	Reserved	
0x813A	Output torque (%)	0.1%	0x819A	Reserved	
0x813C	Output power (kW)	0.1kW	0x819C	Reserved	
0x813E	Output voltage(V)	1V	0x819E	Reserved	

Note:

- 0x8121 ~ 0x813F odd numbers are attribute word of status word 0x8120~0x813E, 0x8181 ~ 0x819F odd numbers are attribute word of status word 0x8180~0x819E
- Attribute use to describe status word, the attribute words from LSB to MSB are Hex/Dec for 1 bit, precision for 2bit, modification for 2 bits and unit for 3 bits
- The register addresses 0x8120 ~0x813F refer to the display parameters corresponding to P2.02, the register addresses 0x8180 ~0x8193 refer to the display parameters corresponding to P2.03
- E5-H: $\leq 3.7\text{kW}$ units output current precision is 0.01A, $\geq 5.5\text{kW}$ units output current precision is 0.1A
E5-A: Output current precision is 0.1A

Control command word (0x8000) description

Bit	Meaning	Bit	Meaning
0	0: Stop command 1: Run command	3	0: Jog running is inactive 1: Jog running is active
1	0: Run forward 1: Run reverse	14	0: Emergency stop is inactive 1: Emergency stop is active
2	0: Fault reset is inactive 1: Fault reset is active	15	0: Coast to stop is inactive 1: Coast to stop is active
Note: Bit 4 to bit 13 are reserved.			

Status word 1 (0x810B) description

Bit	Meaning	Bit	Meaning
0	0: Stop status 1: Running status	5~6	Run command channel selection 0: Operation panel reference 1: Terminal reference 2: Host computer reference
3	0: Forward running status 1: Reverse running status		
4	0: Operation panel keys are unlocked 1: Operation panel keys are locked	8~15	0: Normal Others: Fault code
Note: Bit 1, bit 2 and bit 7 are reserved			

Status word 4(0x810E) description

Bit	Meaning	Bit	Meaning
0	0: Non-jog running 1: Jog running	5	0: Non-open loop multi-step voltage running 1: Open loop multi-step voltage running
1	0: Non-close loop operation 1: Close loop operation	6	0: Normal voltage 1: Under voltage
2	0: Non-open loop multi-step frequency running 1: Open loop multi-step frequency running	7	0: Non-single phase pulse input close loop running 1: Single phase pulse input close loop running
3	0: Non-close loop multi-step frequency running 1: Close loop multi-step frequency running	14	0: Speed control 1: Reserved
4	0: Non-common operation 1: Common operation	15	0: Vector control 1 1: Vector control 2
Note: Bits 8 ~ 13 are reserved.			

◆ Register for input password authentication

Sub function code of PDU	Meaning
0xF000	User password P0.00 authentication and it will be closed automatically if no operation is performed within five minutes
0xF001	PE.00 password authentication for the display and hidden areas of the specially authenticated parameters, and it will be closed automatically if no operation is performed within five minutes
0xF002	A0.00 password authentication for the display and hidden attributes customized areas of the parameters, and it will be closed automatically if no operation is performed within five minutes

◆ Register for parameter attributes

Register address	Meaning	Range	Read (R) and Write (W)
0xF080	Relative address of the parameter	See Appendix Table-1	R/W
0xF081	Current value	0 ~ 65535	R/W
0xF082	Upper limit	0 ~ 65535	R
0xF083	Lower limit	0 ~ 65535	R
0xF084	Factory setting	0 ~ 65535	R

Write the parameter address into 0xF080 by reading and writing multiple register command 0x17 firstly and then read attributes of the parameter.

6. CRC16 Function

```
unsigned int crc16(unsigned char *data, unsigned char length)
```

```
{
    int i,crc_result=0xffff;
    while(length--){
        crc_result^=*data++;
        for(i=0; i<8; i++){
            if(crc_result&0x01)
                crc_result=(crc_result>>1) ^0xa001;
            else
                crc_result=crc_result>>1;
        }
    }
    return (crc_result==((crc_result&0xff) <<8) |((crc_result>>8) ));
}
```

7. Modbus Communication Exemplified

Start the 1# inverter to run forward and set the frequency to 50.00Hz (indicating 5,000 internally)							
	Address	Function code	Register start address	Number	Bytes	Register contents	Check sum
Request	0x01	0x10	0x8000	0x0002	0x04	0x0001,0x1388	0xCEFF
Response	0x01	0x10	0x8000	0x0004	None	None	0xE80A
Read the 1# inverter running frequency of and the response running frequency is 50.00Hz							
	Address	Function code	Register start address	Number	Bytes	Register contents	Check sum
Request	0x01	0x03	0x8136	0x0001		None	0x4C38
Response	0x01	0x03	None		0x02	0x1388	0xB512
Stop the 1# inverter in default mode							
	Address	Function code	Register Address	Number	Bytes	Register Contents	Check Sum
Request	0x01	0x06	0x8000			0x0000	0xA00A
Response	0x01	0x06	0x8000			0x0000	0xA00A

 **Note:**

It needs to set P0.06 to 2 first.

8. Communication Bus Topology

◆ Bus topology of master and slave

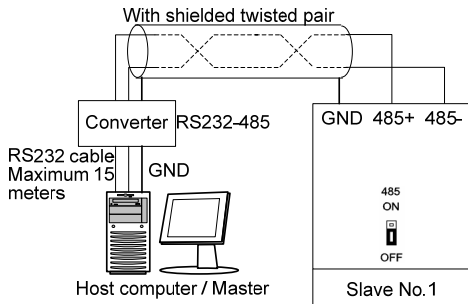

Appendix Figure3 Bus topology of master and slave

◆ Bus topology of master and slaves

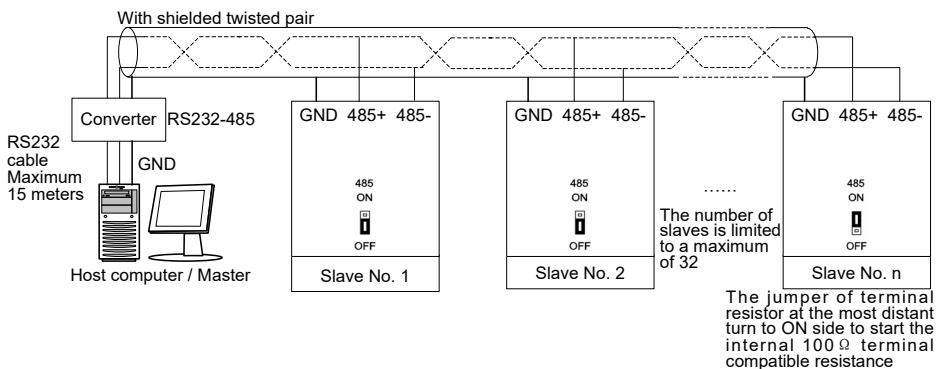

Appendix Figure4 Bus topology of master and slaves

Appendix B E5 Series Hardware Non-standard List

1. E5 Series Hardware Non-standard List

Refer to the “1.1 Product Model Description” in Chapter 1

Hardware non-standard	Function
-14	Replace operation panel type(V6-DP01 or V6-DP02), if 7.5kW and below power class needed V6-DP02 or 11kW and above power class needed V6-DP01, this suffix should be added to product model
-32	Block air intake in the on top of the enclosure
-34	E5-H addition: ①Terminal 485; ②AI3 analog input; ③X5~X7 multi-function input terminal; ④Y2 multi-function output terminal
-63	E5-H addition: ①Terminal 485; ②AI3 analog input; ③X5~X7 multi-function input terminal; ④Y2 multi-function output terminal; ⑤VF power curve; ⑥Input phase loss detection; ⑦High speed pulse input; ⑧PID acceleration and deceleration setting
-68	Provide EX-DT01 digital terminal extension card to increase 4 multi-function digital input and 3 multi-function relay output

2. Differences of each series

Function	E5-H-4T**G	E5-H-4T**G-34	E5-H-4T**-67	E5-A-4T**
Terminal 485	N	Y	Y	Y
AI3	N	Y	Y	Y
X5~X7	N	Y	Y	Y
Y2/DO	N	Y	Y	Y
VF power curve	N	N	Y	Y
Input phase loss detection	N	N	Y	Y
X7/DI configured as pulse input	N	N	Y	Y
PID acceleration and deceleration	N	N	Y	Y
Over load capacity	Constant torque 150%, 60s	Constant torque 150%, 60s	Constant torque 150%, 60s	Variable torque 120%, 60s

Appendix C EX-DT01 Digital Terminal Extension Card

1. EX-DT01 Description

EX-DT01 digital terminal extension card is used for extension of digital input and relay output terminal. EX-DT01 has four digital input terminals and three relay output terminals.

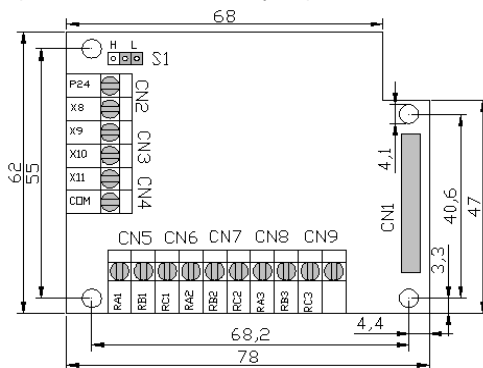

2. Terminal Function Description

Type	Terminal	Name	Description
Power	P24	+24V power supply	
	COM	Ground terminal for +24V	
Relay	RA1/RB1/RC1	RA1 relay output RA1-RB1 normally closed RA1-RC1 normally open	250VAC/1A 30VDC/1A
	RA2/RB2/RC2	RA2 relay output RA2-RB2 normally closed RA2-RC2 normally open	250VAC/1A 30VDC/1A
	RA3/RB3/RC3	RA3 relay output RA3-RB3 normally closed RA3-RC3 normally open	250VAC/1A 30VDC/1A
Digital input	P24	+24V power supply	
	COM	Ground terminal for +24V	
	X8	X8 digital input	Input specification: 24VDC, 5mA Frequency range: 0 ~ 200Hz Voltage range: 24V ±20%
	X9	X9 digital input	
	X10	X10 digital input	
X11	X11 digital input		

3. Wiring mode

- Apply EX-DT01 internal +24V power supply, wiring in NPN sink current wiring mode

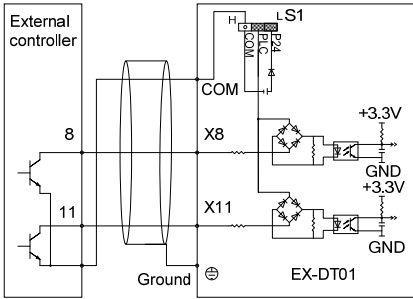

Note:

The jumper S1 must be moved to L side

- Apply EX-DT01 internal +24V power supply, wiring in PNP draw-off current wiring mode

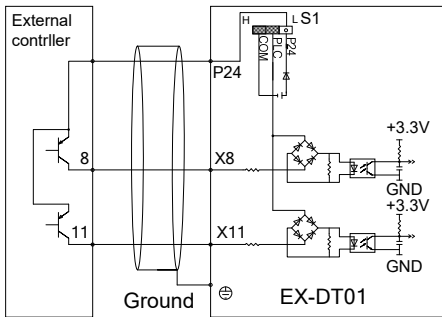

Note:

The jumper S1 must be moved to H side

- Apply external power supply, wiring in NPN sink current wiring mode

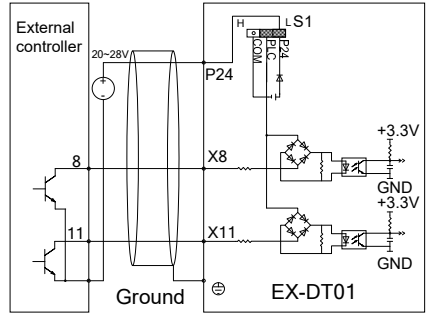

Note:

The jumper S1 must be moved to L side

- Apply external power supply, wiring in PNP draw-off current wiring mode

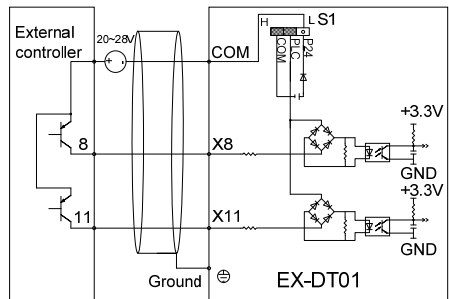

Note:

The jumper S1 must be moved to H side